

GOLD MEDAL AWARDED BY THE STATE OF PENNSYLVANIA,  
ON THE RECOMMENDATION OF THE FRANKLIN INSTITUTE,  
PHILADELPHIA, TO C. FRANCIS JENKINS FOR THE INVEN-  
TION OF THE PHANTOSCOPE, THE FIRST SUCCESSFUL  
MOVING PICTURE PROJECTING APPARATUS.

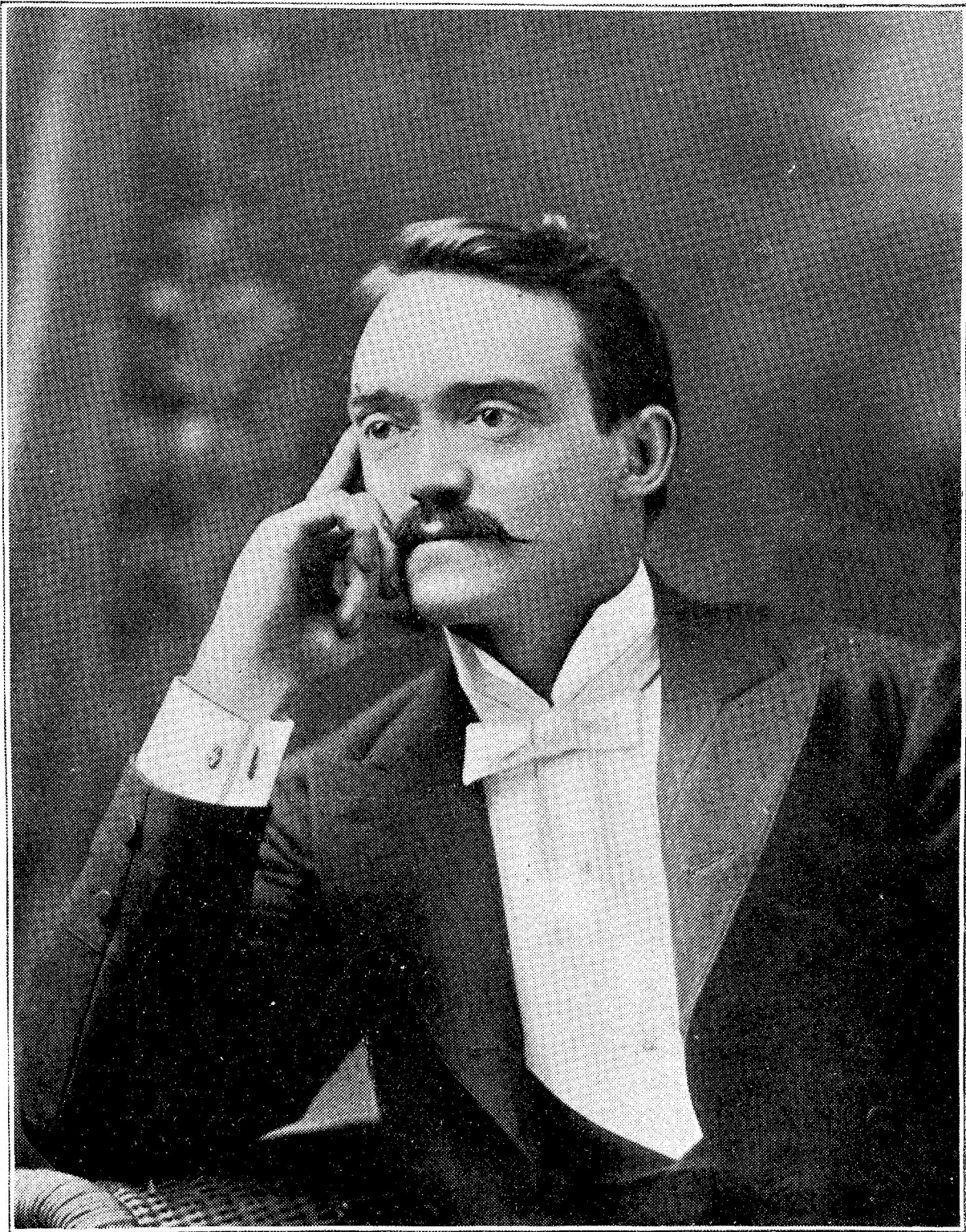





C. FRANCIS JENKINS

# ANIMATED PICTURES

*An Exposition of the  
Historical Development of Chronophotography, its Present  
Scientific Applications and Future Possibilities, and of  
the Methods and Apparatus Employed in the  
Entertainment of Large Audiences by means  
of Projecting Lanterns to Give the  
Appearance of Objects in  
Motion*



C. FRANCIS JENKINS  
WASHINGTON, D. C.  
1898

71706

Entered according to Act of Congress, in the year 1898, by  
C. FRANCIS JENKINS,  
In the office of the Librarian of Congress at Washington, D. C.



**Affectionately Dedicated**  
TO MY  
CHRISTIAN MOTHER  
THE AUTHOR OF ALL MY AMBITIONS



## Preface



TWO things will very probably impress themselves upon the non-professional readers of this book: One is that the moving picture mechanism which has been so widely exploited during the past two years is the culmination of a very long series of experiments. The sensational appearance of these machines in a relatively perfect form has given rise to the impression that they were something new under the sun, a sort of Minerva-birth of inventive genius. In his historical sketch the author has shown that like all notable achievements in mechanism animated picture machines had a long line of predecessors, and that the difficult problem of recording and reproducing motion has not yielded without much preliminary fumbling. But the greatest interest of the book (ignoring its value as a hand-book for professionals) lies in the attention it calls to the yet undeveloped possibilities of chronophotography. Thousands have been entertained and amused by moving picture exhibitions, have laughed at the vigorous osculations of the "Widow Jones" and have felt the excitement of a realistic fire scene. But the Phantoscope and its rivals have a more serious mission than that of reproducing, however vivid, trivial and familiar happenings. They doubtless will become adjuncts to omnipresent journalism and will bring palpably to our eyes the

remote and phenomenal. Above all uses of entertainment is the service which perfected chronophotography can render to science and art. The applications of simple photography in these fields are already numerous and valuable, and with the certain perfecting of orthochromatic photography and chronophotography the means for recording the physical phenomena of nature and life will be complete. In color, form, and motion every aspect of a fact may then be seized and reproduced at will, and if the anticipation of the author be well founded, with all the depth and atmosphere of a stereoscopic picture. These happy results may seem based on a multiplicity of conditions, but it is not with cold reason that the possibilities of invention may be gauged. The machine which is to-day a curious entertaining toy is destined to touch life at many points of beauty and utility.



# Contents



|  | PAGE     |
|--|----------|
| <b>ANIMATED PICTURES</b>   |          |
| The Philosopher's dream.   |          |
| A precipitate of many scientific experiments.  |          |
| A slippered foot performs an erstwhile herculean task.   |          |
| <b>CHRONOPHOTOGRAPHY . . . . .</b>   | <b>1</b> |
| Its origin in the zoetrope of an hundred years ago.  |          |
| What suggested the invention of the zoetrope.  |          |
| Animated picture projecting lanterns and photographic processes.   |          |
| Marvelous beauty of these phantom pictures.  |          |
| Human retina a living photographic plate.  |          |
| No invention so universally, quickly exploited.  |          |
| Plan of construction generally followed.   |          |
| Different steps in the evolution of its successful application.  |          |
| <b>AN HISTORICAL SKETCH . . . . .</b>  | <b>5</b> |
| Plateau's phenakistoscope, a father to them all.   |          |
| Seller's zoetrope, first pictures photographically obtained.   |          |
| Brown's animated picture projecting lantern.   |          |
| Heyl's phasmatrope, pictures by wet plate process; Academy of Music, Philadelphia, 1870.   |          |
| Janssen's photo-revolver, used in study of planetary bodies.   |          |
| Doristhrope's kinesigraph, a modified zoetrope using a ribbon of paper.  |          |
| Muybridge's brilliant experiments in animal locomotion. Upwards of half a million dry plates used; his valuable bookplate collection; the zoopraxiscope.       |          |
| Marey's single-plate camera. Photographic gun; daylight spools with black and red leaders.   |          |
| Demeny's photoscope, a boon to deaf mutes.   |          |
| Mach's studies of plant life.  |          |
| Reynaud's optical theatre, the praxinoscope.   |          |
| Le Prince's anticipation of present processes. Perforated film in long lengths, and colored transparent ribbons; 1886.   |          |
| Levison's plate-carrying cylinder camera.  |          |
| Ancheutz's tachyscope. Vacuum tube illumination; his exhibit at the World's Columbian Exposition.  |          |
| Edison's kinoscope. Its evolution; first experiments; his phono-kinoscope, or kineto-phonograph. Where he got the vitascope; sale of territory and a monopoly. |          |

Lumiere's cinematograph. The pellicular band fed with hooks or reciprocating prongs and triangular movement; camera, printer and projector in one.

Castler's biograph. Uses wide, thin, unperforated film; method of keeping the picture in register; the use of the tachometer.

The mutoscope. A nickel-in-the-slot machine; a cylinder full of picture cards; the simplicity of its construction and operation; the performance under the control of patron.

Pocket edition mutoscope. A pack of picture cards; a pair of hands the only requirements for an exhibition.

A single-picture kinoscope. The segmental cylindrical lens; a laughing and crying face from a single picture.

Parlor kinoscope. Pictures on a paper ribbon; How the negatives are secured; how the half-tone printing blocks are made; the after methods.

## A MULTINOMIAL MACHINE . . . . . 24

Selected list of 150 of them.

## THE PHANTOSCOPE . . . . . 25

A fanciful name for the apparatus used by Jenkins. Its conception, inception and development; the exhibit at the United States National Museum.

Pawl-and-ratchet camera-projector. A 75 per cent. shutter; oil lamp illumination; unperforated film.

A shutterless camera. An explanation of the paradox; unperforated 2½-inch film.

A rotary-lens camera-projector. Making pictures on a constantly moving sensitive surface a radically new departure; how accomplished.

Crank-spool camera. Winding unperforated film on eccentrically located rotating spools.

A second rotary camera-projector. Light-proof film boxes, analogous to plate holders; measuring light, the rapidity of lenses, and sensitiveness of photographic surfaces.

Intermittently-biting rollers, for camera film feed. Common in certain forms of fabric machines.

Bell-crank prongs, for camera film feed. Self-perforating.

Cabinet picture machine. Pictures illuminated by flying lights; automatic timing device.

Elliptical gear projecting machine. Gradual alternate acceleration and diminution of the feed.

Intermittent gear shutterless projecting machine. Arc lamp illumination; mental impression of picture ten times as strong as impression of movement.

A disc device, with spirally arranged pictures upon surface; intermittent feed.

A second cabinet, stationary light, constantly illuminated picture band, viewed in revolving mirrors, film fed continuously.

"Knocker" projecting machine, the first successful projecting machine for canvas use publicly exhibited, heat absorbent cells; no jerky motion of mechanism; magnificent exhibit at Cotton States and International Exposition, Atlanta, Ga., 1895.

Camera for making commercial films. Film 3-1000 inch thick shows halation.

Sun and planet gear novelty.

A rotary lens camera with shutter. 250 pictures per second; how accomplished.

A miniature projecting machine cabinet. Pictures 12 inches square.

A cabinet 6 x 8 foot picture; automatic coin-actuated; accommodating twelve patrons simultaneously.

Simple moving picture attachment for projecting lanterns.

Rotary attachment; lens carrier set askew to the axis of optical system.

Traveling lens attachment; nine  $\frac{1}{4}$ -size objectives.

A novel experiment with ordinary projecting lantern.

Camera-projector for wide unperforated film. No shakiness of picture on screen.

## TWO HUNDRED REFERENCES IN THE ART . . . . . 43

Different machines, descriptions of which were published prior to May, 1896.

## COMMERCIAL APPLICATIONS . . . . . 45

Entertainment of large audiences.

Picture ribbon photography.

The construction and operation of the camera.

The lens used, and why.

The shutter.

Intermittent feed.

Detachable film boxes.

Focusing, leveling, and the finder.

Leaders; and threading the camera.

A specially rapid shutter, how made.

The choice of a camera lens.

Lenses marked in "f" numbers; what it means.

The subject, time of day, season of year, distance, etc.

Valuable information by chronophotographic cameras.

Ray filters, easily made, and the methods.

Tele-photo lenses and animated pictures.

Novel combination for large pictures of distant objects.

Cabinet-size picture of Statue on National Capitol, at distance of two miles.

## DEVELOPMENT . . . . . 54

The long uncut strip.

Loose in a developing solution.

The drum method.

The pin-tray method.

The flanged-spool method.

Hardening, and soaking solutions.

The temperature.

Drying the film.

Development, the simple chemistry of it.

Causes of failure, and how to avoid them.

Darkroom illuminant, the best, and how tested.

|   | PAGE |
|---|------|
| PRINTING . . . . .                                    | 58   |
| The several methods.                                  |      |
| The light, and continuous feed.                       |      |
| The temperature.                                      |      |
| Inperfect registration.                               |      |
| Developing the positive.                              |      |
| Splicing the ribbon.                                  |      |
| The best splicing solution.                           |      |
| PERFORATING THE RIBBON . . . . .                      | 62   |
| The perforator, how built.                            |      |
| An odd paradox.                                       |      |
| The working rate.                                     |      |
| Generation of static charges.                         |      |
| Sharpening the perforator teeth.                      |      |
| A perforator unnecessary, and why.                    |      |
| The different kinds of perforations, and why adopted. |      |
| How a sprocket is cut, and the shape of the teeth.    |      |
| COATING THE WEB OF CELLULOID . . . . .                | 67   |
| The coating machine.                                  |      |
| The drying apparatus.                                 |      |
| Splitting the web into ribbons.                       |      |
| Measuring the film.                                   |      |
| LANTERN PROJECTION . . . . .                          | 68   |
| The entertainment, how conducted.                     |      |
| Announcements.  |      |
| The orchestra.  |      |
| Illuminating the auditorium.                          |      |
| The use of blank film.                                |      |
| The illuminant.                                       |      |
| A long optical system.                                |      |
| Heat absorbents.                                      |      |
| Danger of fire, how avoided.                          |      |
| Registering the pictures.                             |      |
| Machines in the balcony, and why.                     |      |
| Laws governing moving picture projection.             |      |
| The screen, and what is best therefor.                |      |
| Tables of distances and size of picture.              |      |
| Wide film, and its many advantages.                   |      |
| Hand feed arc lamp.                                   |      |
| Calcium or oxy-hydrogen light.                        |      |
| Comparative cost of each.                             |      |
| Pressure in arc, and the rheostat.                    |      |
| Heat, and how harmlessly absorbed.                    |      |
| Cored carbons ; set at an angle.                      |      |
| The hot carbon ; and blowing out the arc.             |      |
| Using a street-railway current, and the rheostat.     |      |



|  | PAGE |
|--|------|
| FEATURES . . . . .   | 37   |
| Construction of projecting machines.                         |      |
| The uselessness of a shutter.                                |      |
| The Geneva stop motion.                                      |      |
| Turning the apparatus by hand advantageous.                  |      |
| A train speed of 120 miles per hour.                         |      |
| Falsifying a record ; slow, fast.                            |      |
| A new non-scratching tension plate.                          |      |
| A new feature with two lanterns.                             |      |
| Another ; chromatic effects.                                 |      |
| Tinting the ribbons, and what colors to use.                 |      |
| Projecting upon banks of mist and upon the clouds.           |      |
| An automatic coin device for heavy currents.                 |      |
| A feature of crank-pin machines.                             |      |
| A peculiarity of animated pictures of rare occurrence.       |      |
| \$25 for a picture for 1-12th of a second's use.             |      |
| A very remarkable moving picture exhibit.                    |      |
| Shakiness of the picture ; a sheet in the wind.              |      |
| Opera glasses, how to use them to rest the eyes.             |      |
| Flickering and shakiness, the difference.                    |      |
| Eye-fatigue, cause and remedy.                               |      |
| Peculiar sea-sickness from watching certain pictures.        |      |
| Reversals, what they are and how secured.                    |      |
| A reversed-picture film, and how to make it.                 |      |
| An imponderable shutter, the fastest possible.               |      |
| Moving pictures in advertising.                              |      |
| Screen announcements and how quickly made.                   |      |
| Lantern pictures on a single strip.                          |      |
| How to use the secondary lantern.                            |      |
| Keystone shaped pictures, and how to correct.                |      |
| Harmonious sensations of sound by means of colors.           |      |
| Copyrighting films, does it protect? What to file.           |      |
| Stereoscopic projection, three successful methods.           |      |
| A new scientific instrument of great utility.                |      |
| A new departure for chronophotographic projection.           |      |
| Photographing the lips in spoken sentences.                  |      |
| Reproducing same that the deaf may read on canvas.           |      |
| Some new results of scientific value and singular beauty.    |      |
| The growth of a plant or flower.                             |      |
| Microscopical investigation aided.                           |      |
| The changing animation of a baby's face recorded.            |      |
| Leaves turning to follow the sun all day.                    |      |
| Following the progress of the seasons.                       |      |
| Reproducing the photographs of a dragonfly's wings.          |      |
| Animated pictures in natural colors and stereoscopic relief. |      |
| The realization of the philosopher's dream.                  |      |

|  | PAGE |
|--|------|
| FORMULAS . . . . .   | 107  |
| Pyro developer.  |      |
| Fixing baths.  |      |
| Soaking solution.  |      |
| Oxalate of Iron developer.                                       |      |
| Eikonogen-Hydrochinone.  |      |
| Hydrochinone-Metol.  |      |
| One solution Pyro developer.                                     |      |
| Para-hydro-quinone.  |      |
| Metol.   |      |
| Glycin.  |      |
| Ortol.   |      |
| Rodinal.   |      |
| Miethé.  |      |
| Pyro-ammonia.  |      |
| Pyro-acetone.  |      |
| Para-amidophenol.  |      |
| For cloud negatives.   |      |
| Intensifiers.  |      |
| Reducers.  |      |
| Chromatic colors.  |      |
| Hypo eliminator.   |      |
| Removing stain from fingers.                                     |      |
| Removing silver stains.  |      |
| Splicing solutions.  |      |
| Formaline and aluminum hardeners.                                |      |
| To recover fogged film.  |      |
| Ink for writing on bottles.                                      |      |
| To keep labels clean.  |      |
| Adhesive for cloth to metal.                                     |      |
| Leather collodion.   |      |
| Water-proof cement.  |      |
| Retouching varnish.  |      |
| Transferring newspaper cuts in colors direct to a lantern slide. |      |
| Blue prints and blue print solutions.                            |      |
| Printing papers sensitive to light.                              |      |
| Printing papers sensitive to heat.                               |      |
| Printing papers sensitive to moisture.                           |      |
| Printing papers sensitive to electricity.                        |      |
| Water pictures.  |      |
| Weights and measures.  |      |
| Wet plate process.   |      |
| Toning and fixing.   |      |



1331 CONNECTICUT AVENUE,  
WASHINGTON, D. C.

April 24, 1896.

Mr. C. FRANCIS JENKINS,

MY DEAR SIR:

I must thank you for the opportunity you have afforded me of seeing your Phantoscope in operation.

The simple and ingenious mechanism by which you have secured an intermittent motion of the photographic film has enabled you to employ a continuous light of great intensity, and I must congratulate you upon your success in throwing upon the screen life-sized moving photographs with such remarkable fidelity to nature.

Wishing you every success, I am, my dear sir,

Yours sincerely,

ALEXANDER GRAHAM BELL.

*“Doth this motion please thee.”*

—SHAKESPEARE.

## ANIMATED PICTURES

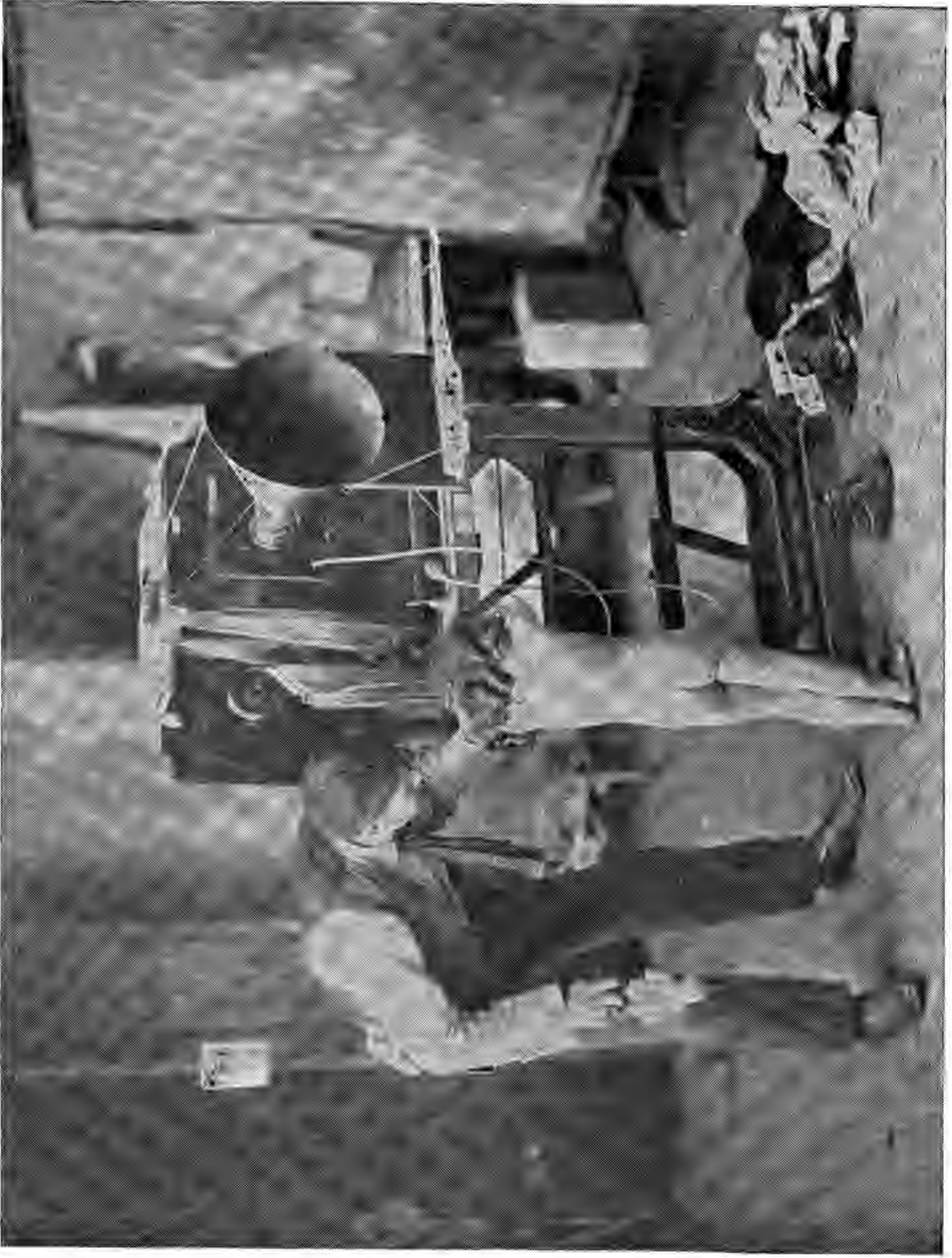



## THE DEVELOPMENT OF CHRONOPHOTOGRAPHY.

To give life to inanimate things has been the dream of philosophers for ages, but to paint pictures and imbue them with animation is the ambition of more practical investigators, and the evidence of the success of such endeavors is their daily accomplishment. Hosts of eminent scientists have worked upon the problem, and the precipitate of knowledge from thousands of experiments has afforded a harvest of interesting results and rendered the accomplishment of an erstwhile herculean task so simple that a child can startle an audience into a tumultuous storm of applause. She stamps a little slippered foot and electricity, that most plastic of all forms of energy, does the rest.

Chronophotography, the idea of conveying by persistence of vision a counterfeit impression of objects in motion through the display in rapid succession of a series of related pictures, had its origin in that ingenious little toy, the zoetrope, or wheel of life; at least, so it is customary for writers and speakers on this subject to initially announce, though none of them has ever attempted to say what suggested the zoetrope, for this toy, a revolving open pasteboard cylinder with its many lateral slits between which on the inside were

pasted a series of related pictures, was as novel in its time as the animated projecting machines of to-day.

However, on this point the writer offers no opinion, for it is always difficult to determine the birth of an idea resulting in an invention of worth. Job stood in reverential admiration of the resplendent beauty of a silken-coated horse in muscular

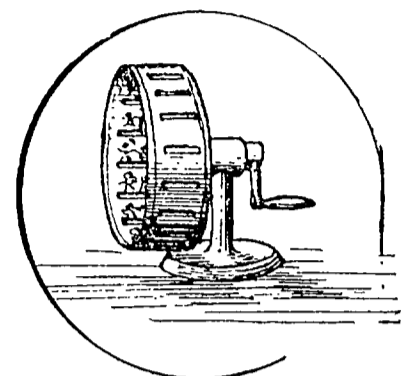

activity; and if these pictures were not known before the Christian era, it is difficult to conceive what Titus Lucretius Carus meant in his work, "De Rerum Nature," book iv, verse 766, written between 95 and 65 B. C., which, pretty closely translated, reads:

Do not thou moreover wonder that the images appear to move,  
And appear in one order and time their legs and arms to use,  
For one disappears, and instead of it appears another  
Arranged in another way, and now appears each gesture to alter,  
For you must understand that this takes place in the quickest time.

However, since the invention of the zoetrope the progress of photographic chemistry has wonderfully increased the sensibilities of negative surfaces, making possible a new class of instruments, *i. e.*, lanterns which project pictures absolutely true to life in every feature, a masterpiece of photographic realism. As portrayed, the bare canvas before the audience instantly becomes a stage, upon which living beings exhibit actual muscular activity and perform their respective parts, moving, gesticulating, and changing expression with astonishing vividness. There is a momentary period of darkness and the scene changes. This time the spectators see the sweep of angry waves as they beat furiously against the masonry of the piers,



while the spray dashes high in the air. The changing scenes as pictured on the canvas follow each other with startling rapidity, a process which seems to breathe very life into the records of the camera.

The whole depends for its accomplishment upon the persistence of luminous impressions on the human retina, as when one swings a lighted lantern at arm's length about one's head. To be more explicit, the retina of the human eye behaves very much like a photographic plate in that it will take impressions of light, but differs in these respects; the impression soon fades when the light vanishes, it can not be injured by prolonged exposure, under ordinary circumstances, is not susceptible to heat rays, and will not take two impressions at the same moment. The latter fact is the one quite largely depended upon to secure in lantern projection the results referred to.

Few inventions have been so quickly and generally exploited as that of animated pictures. The perfection of the invention (so far as it has been perfected) provides a rapid and efficient means whereby scenes of to-day may be recorded for the instruction or entertainment of those unable to witness them in person, as well as for the benefit of posterity.

The generally adopted method consists in making on a long ribbon of pellicular fabric a series of consecutive photographs representing all the constantly changing phases of action of a scene. The camera in which these photographs are made consists of a casing or box with lens and shutter and devices for rapidly shifting the sensitive surface in

the focus of the lens. This roll of sensitive film is unwound past the lens, exposed and afterward rolled again. After development a positive or transparency is printed therefrom, the roll subsequently being placed in the projecting lantern. This lantern is fitted with practically the selfsame mechanism used in the camera for unwinding the film, passing it behind the projecting lens and winding it again, all in such manner as to give upon the screen a single enlarged picture of the scene photographed, and with all the action of the original in a continuous and harmonious reproduction of singular fidelity. This is the plan employed in most cases, although there are a few devices embodying different and very ingenious modifications.



## AN HISTORICAL SKETCH.

THE different steps in the evolution of a successful application of the art to lantern projection consisted of the employment (1) of a series of related pictures, (2) of photographic processes to secure them, (3) of a single camera, (4) of perforated film, (5) of intermittent feed, and (6) in making the period of illumination exceed the period of change or substitution of the pictures in the series.

A sketch of the apparatus which have been designed as means to this end would, therefore, probably begin with Plateau's efforts, early in the present century—published in 1829. By a process of synthesis he reproduced, by means of his phenakistoscope, pictures which fairly well represented objects in motion, and oddly enough he was blind. A very similar device was Stamper's stroboscope of about the same time.\*

The first investigator to secure a patent on a device for producing pictures to give the appearance of objects in motion was the eminent engineer, Colman Sellers, who, observing the apparent want of illumination in the various

---

\* To describe all the different apparatus known or used, would make this historical sketch inordinately long. Only such examples are selected as seem to mark the different steps in the art. Several times as many apparatus are cited later on, and will be found of great value in a fairly accurate determination of priority of invention in this art.

modifications of the zoetrope, set about the construction of a device to remedy the trouble. He builded a very ingenious apparatus in which advantage was taken of the fact that an image does not lose its shape or general character by being thrown slightly out of the exact focus of the eye at any moment. He caused the pictures, which were made stereoscopically, to approach the eyes some little distance before being suddenly jerked out of the line of vision to uncover the next picture in the series. The picture was thus impressed upon the retina for a considerable time, although, theoretically, it was sharp at but one point. This permitted a much longer illumination than had heretofore been possible, and without detriment to the picture. The device in one form of which the pictures were on an endless band, was made the subject of United States patent No. 31,357, issued February 5, 1861. The writer believes these pictures were the first ever made in a camera for exhibition so as to give the appearance of objects in motion.

In 1869 an American patent, No. 93,594, was issued to A. B. Brown for a lantern adaptation of the zoetrope; a modification showing a series of related pictures moving step by step in a manner almost identical with that shown in dozens of machines to-day, and as successful had he removed the shutter used. The pictures were not photographs, but the positions were guessed at, and drawn or painted upon glass.

The writer has in his possession a program of an entertainment, given at the Academy of Music in Philadelphia on the evening of February 5, 1870, in which the phasmatrope



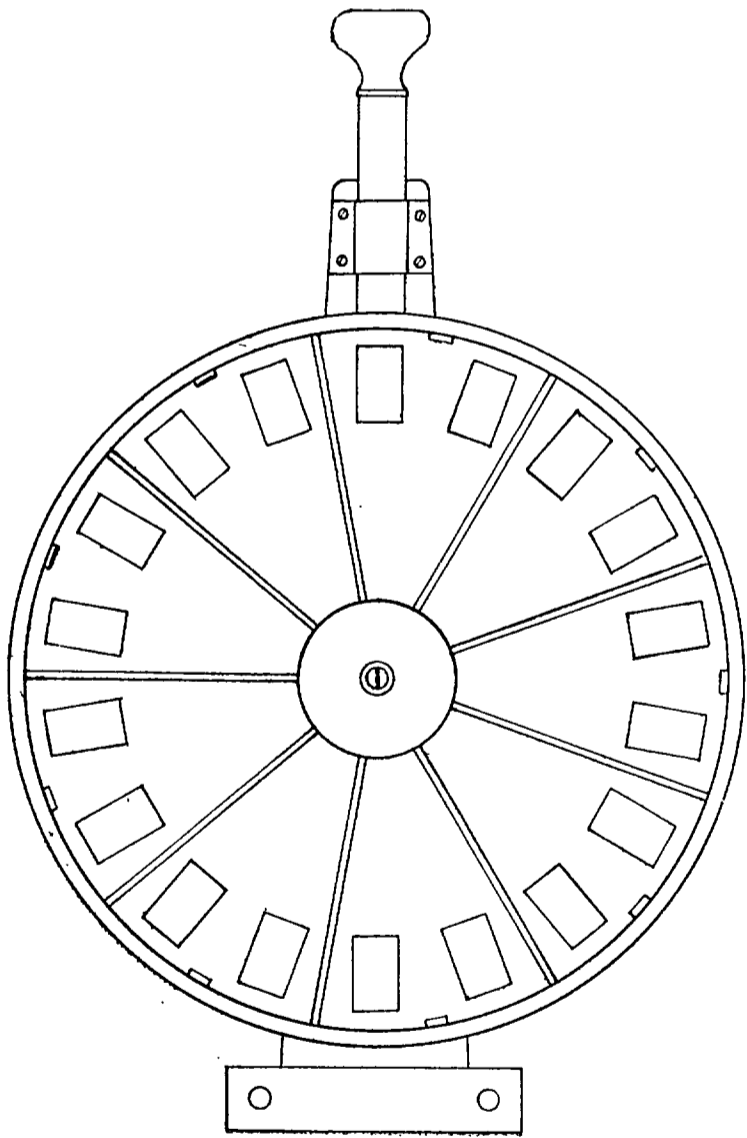
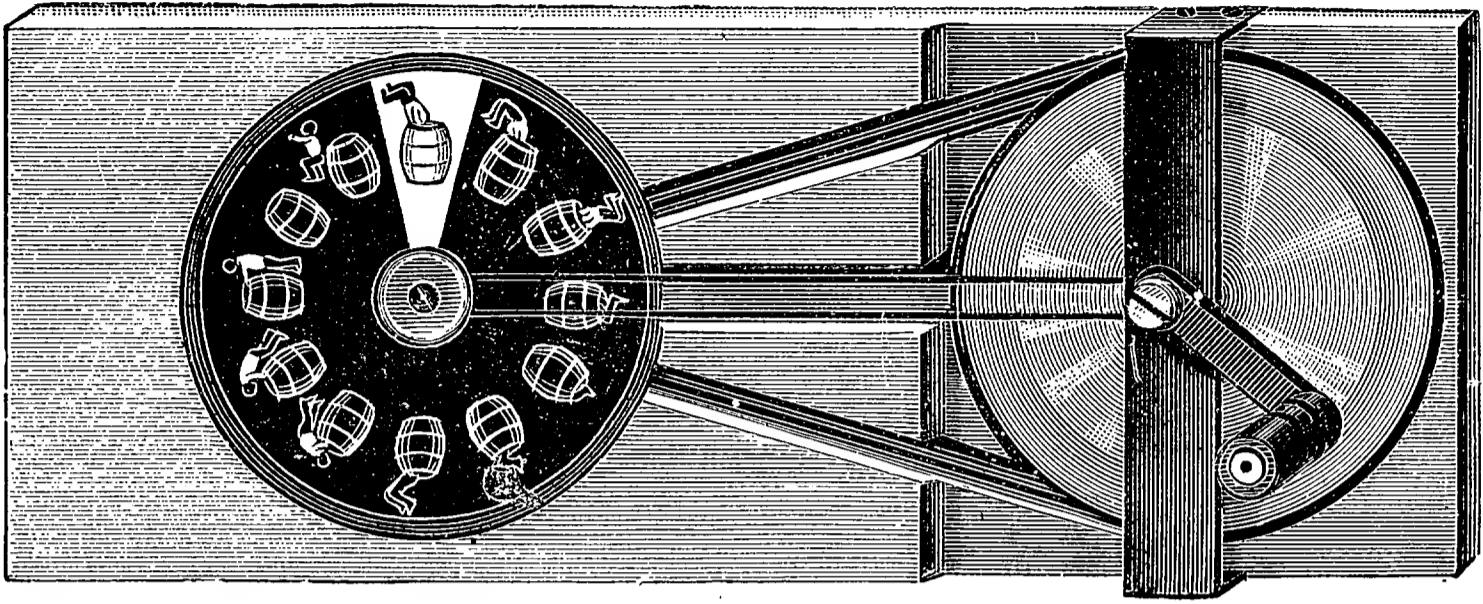

was introduced. This brilliant conception was due to the ingenuity and photographic skill of Henry R. Heyl, of that city. The exhibition was repeated by him before the Franklin Institute March 16th following. These were the first exhibitions known to the writer of photographs to represent in motion living subjects projected by a lantern upon a screen.

The subjects exhibited embraced waltzing figures and acrobats, shown in life-size from photographic images  $1\frac{3}{4}$  inches in height. At that day, flexible film and instantaneous exposures were unknown; therefore it was necessary to limit the views of subjects to those that could be taken by time exposures, upon wet plates, which photos were afterwards reproduced as positives on very thin glass plates. The waltzing figures, taken in six positions, were triplicated in order to fill the eighteen picture spaces of the exhibiting disc attached to the lantern.

The device consisted of a skeleton wheel having radial divisions into which could be inserted the picture holders, each consisting of a card upon which were mounted two of the photo positives, in such relative position that as the wheel was intermittently revolved each picture would register exactly with the position just left by the preceding one. The intermittent movement of the wheel was controlled by a ratchet and pawl mechanism operated by a reciprocating bar moved up and down by the hand. It will be apparent that the pictures could be moved in rapid succession or quite slowly, or the wheel could be stopped at any point to complete an evolution.

In the exhibition at the Academy, above alluded to, the movement of the figures was made to correspond to the time of the waltz played by the orchestra, and when the acrobatic performers were shown a more rapid motion was given, and a full stop was made when a somersault was completed. The vibrating shutter placed back of the picture wheel was operated by the same draw bar which moved the wheel, only the shutter was so timed that it moved first, and covered the picture before the latter moved, and completed its movement after the next picture was in place.

In 1874 Dr. Janssen used a "sort of photo-revolver" for chronophotographic records of the movement of certain celestial bodies. Photos, seventy seconds apart, were made of the transit of Venus across the sun.

But it is to the investigations of Muybridge that we are indebted for the most scientific researches on the subject. Muybridge's experiments in animal locomotion have become famous the civilized world over, and are preserved in large bound volumes of book plates, the author's edition of which is valued at \$2,500. His photographs of a horse trotting, pacing, jumping and running were revelations; but progress in instantaneous photography has made such phenomena so familiar that pictures of a horse with one foot on the ground and three feet bunched together in the air are no longer remarkable. He used upwards of half a million plates in his experiments, which were begun at Sacramento race tracks in 1872. Wet plates were used and exposures of  $\frac{1}{5000}$  of a second are said to have been made. Subsequent experiments were conducted under the generous support of



the late Senator Stanford. The odd pictures obtained were projected, at rates varying from twelve to thirty-two per second, by means of the zoopraxiscope to illustrate a lecture on animal locomotion delivered in San Francisco. This illustrated lecture was repeated in Paris at the Electrical Exposition, 1881; again in London in 1882; and in 1883 in Boston, New York, Philadelphia, etc.

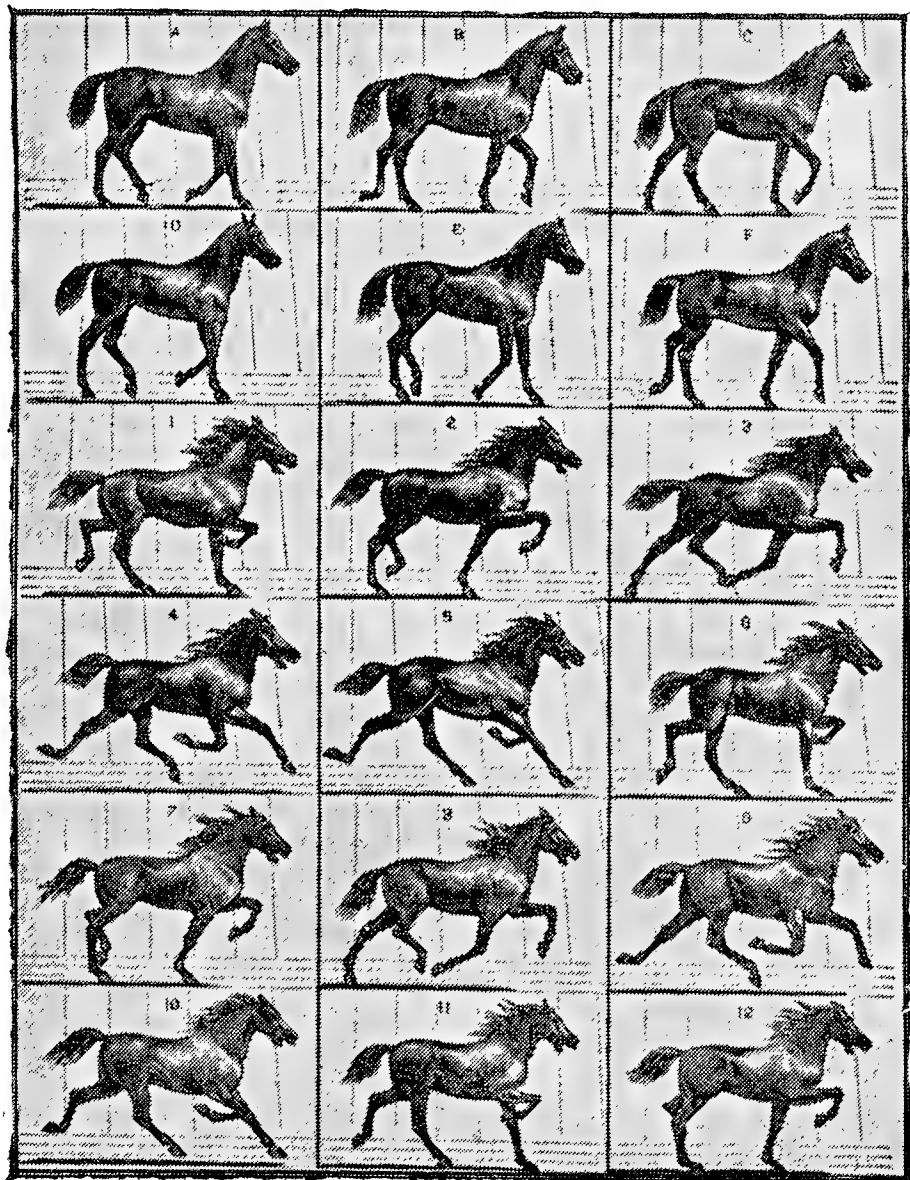

MUYBRIDGE'S EXPERIMENTS.

In the paper read before the Franklin Institute he says (*Franklin Institute Journal*, April, 1883): "In 1877 I invented a method for the employment of a number of photographic cameras arranged in a line parallel to a track over which the

animal would be caused to move, with the object of obtaining, at regular intervals of time and distance, consecutive impressions of him during a single complete stride as he passed along in front of the cameras." These cameras were arranged at regular intervals opposite a white inclined reflecting surface. Fine threads were connected with the shutters of the cameras, and as the horse passed along the track the threads were broken which released the shutters of the cameras in succession, the series of photographs thus obtained having the various attitudes assumed by the animal at the moments of exposure. In subsequent experiments the releasing of the shutters was done electrically at uniform intervals and independent of the advance of the horse. From 1883 to 1887 he was engaged in like work at the University of Pennsylvania, where his "Animal Locomotion" was published. His zoopraxiscope consisted, as to novelty, of an immense disc, or wheel, one of which is said to have been thirteen feet in diameter. Upon this disc in regular and consecutive order, were arranged glass positives of the negatives made at the track. This disc was rotated so that the pictures were brought one after another into the light of a projecting lantern, a vertical reciprocating shutter obscuring the light during the interval of movement or substitution of pictures. On February 27, 1888, Muybridge had an interview with T. A. Edison, "that celebrated improver of inventions," as to the possibility of combining the phonograph with the zoopraxiscope, explaining how the pictures could be made therefor.

November 9, 1876, an English patent, No. 4344, was issued to Wordsworth Donisthrope, in which he shows and

describes a mechanism for making photographs on a pack of glass plates (like a pack of cards) pushed to the focus of the lens and exposed one at a time, then dropped down and out of the way of the next plate at a rate of about eight exposures per second. In the same patent he also says:

“If the apparatus be arranged to take the successive pictures at sufficiently short intervals of time they may be printed at equal distances upon a continuous strip of paper. This paper with the whole series of pictures upon it may be used in the instrument known as the zoetrope or phenakistoscope. To allow of this the strip of paper may be wound on a cylinder, to be wound from it at a uniform speed on to another cylinder and so carried past the eye of the observer, any ordinary means being used for insuring that each picture shall only be exposed momentarily to the observer. By this means the movement made by a person or group of persons or of any other objects during the time they were being photographed may be reproduced to the eye of the observer.”

He called the device the kinesiograph, and with it he recorded and reproduced “the growing grass, buds developing into flowers, tadpoles into frogs.”

In *Nature*, issue of January 24, 1878, he explains another modification together with the combination of the kinesiograph and the phonograph. “Each picture as it passes the eye is instantaneously lighted up by an electric spark. Thus the picture is made to appear stationary, while the people and things in it appear to move as in nature \* \* \* reacted on the screen of a magic lantern, and with the assistance of the phonograph the dialogues may be repeated

in the very voices of the actors, \* \* \* and also the photos in colors." This was made the subject of another English patent, issued August 15, 1889.

The next to come prominently into notice was Marey. After meeting Muybridge in Paris in 1881, Marey set about to determine, at first by graphic methods, the trajectories, velocities and accelerations of moving parts of the human body, aquatic locomotion, etc., etc., analyzing phenomena that take place so quickly that the eye can not perceive the different phases of their displacement. In his apparatus he employed first a single plate to different parts of which he reflected the image at each successive exposure by means of a revolving mirror, and afterwards (1887) a long roll of sensitive film which was fed behind and in the focus of a photographic lens. In this, as in all the cameras then known, to secure sharp images it was considered necessary that the sensitive surface should stop and be held immovable during exposure. This was accomplished by allowing the spool rotating mechanism, which fed the film, to continue working while a small part of the film, a loop, should be momentarily arrested by being pressed against a glass plate located in the focus of the lens. The constantly rotating spool in the meantime takes up the slack against the action of a spring, which quickly flies into position, taking the film with it, the moment the pressure holding the film immovable behind the lens is released. In another form he pulled the film along by friction which allowed it to stop, when gripped in the focus of the lens, while the frictional traction-rollers continued to revolve. Exposures of  $\frac{1}{1000}$  of a second, using

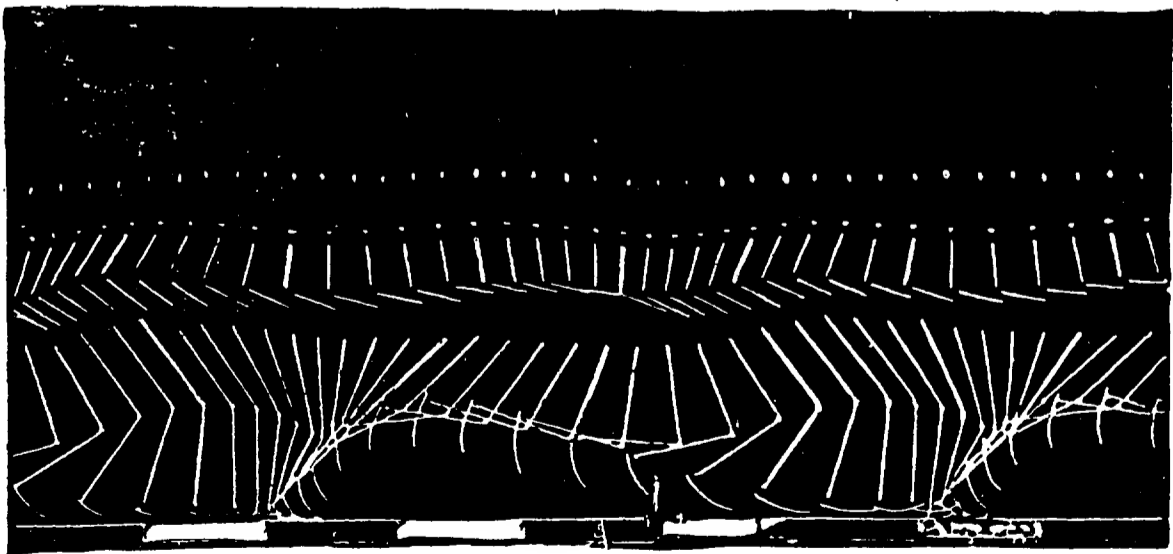

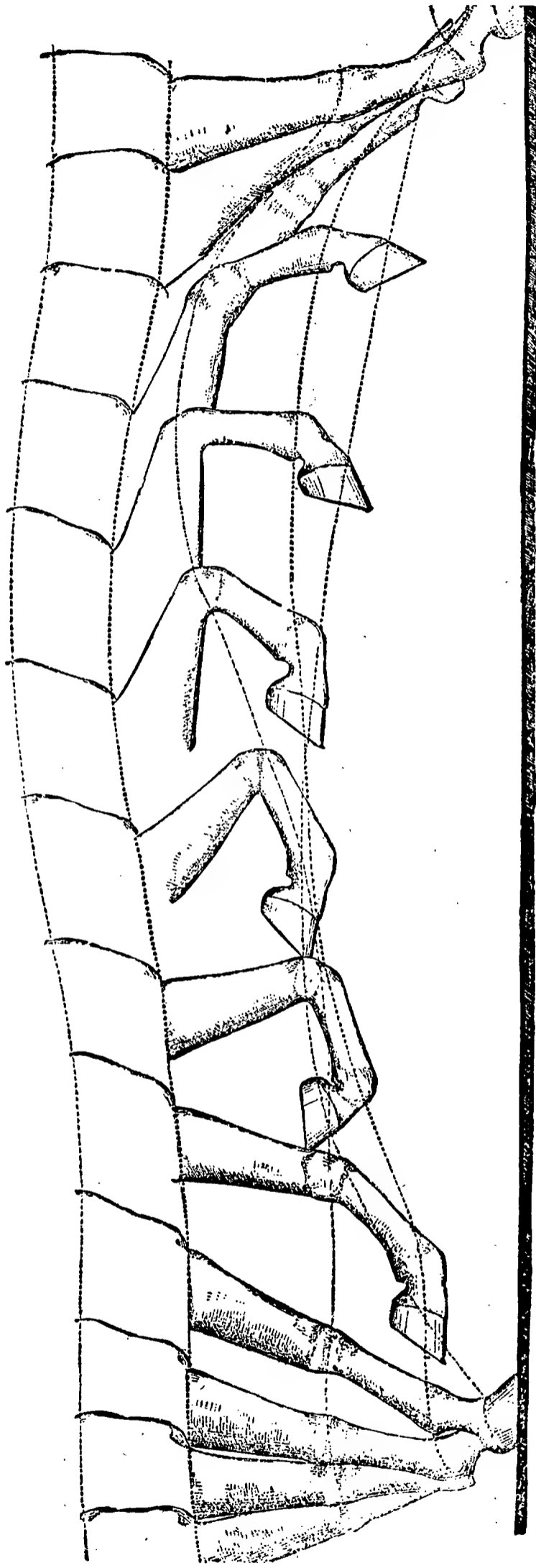

a rotating disc shutter, were made. He used "daylight spools" with "leaders" of black on the leading and red on the following end, which enabled him to readily distinguish an exposed from an unexposed spool. He also designed and used a "photographic gun," the barrel of which contained the lens. A hollow cylindrical breech piece contained a clock-work mechanism for rotating a negative step by step. In 1891 he presented to the French Academy of Sciences pictures of an insect in flight silhouetted against the solar disc. There were twelve pictures on each plate, and the exposures are said to have been but  $\frac{1}{20000}$  of a second in duration. In 1889 Edison interviewed Marey on the subject of moving pictures, the latter showing him his method of reproducing the pictures on his picture bands.

Demeny, with his photoscope, which was designed especially for reproducing the motion of a man's lips, was so successful that deaf mutes were able to read the photographed sentences. The photographs were made upon a celluloid band, and from this a positive band was printed which, as it passed before the eyes, was illuminated by a small incandescent lamp situated beneath the band. Demeny was an assistant to Dr. Marey.

Mach utilized similar means in studying growing plants. Photographs were made at regular intervals, say, twelve hours apart, which were afterward reproduced before the eye so as to give the startling phenomenon of a rapidly growing plant. The spectator witnesses a very curious scene; he sees the plant grow before his eyes and is able to follow all its transformations. The development at first very rapid is progressively retarded, a period of great activity preceding

one of relative repose. At this moment the flowers appear. One sees them expand and wither. The plant itself is subject to the same laws, the whole process of birth, growth, flowering, fruiting and decay occupying a space of time which may be counted by seconds.

Somewhat later Reynaud constructed a very ingenious optical lantern. His pictures were each made by hand on transparent flexible ribbon,—a most laborious process. The object of his “optical theater,” the plaxinoscope, was to reproduce the pictures on a considerable scale.

But without doubt Augustus Le Prince, of New York State, in 1886, when he filed an application in the United States Patent Office, serial No. 217,809, came nearer anticipating future methods and materials than any one on record. He employed perforated film in long lengths, the positive of which was “of transparent gelatine, mica, horn, etc.” His experiments form an important link in the history of the synthesis of animated motion.

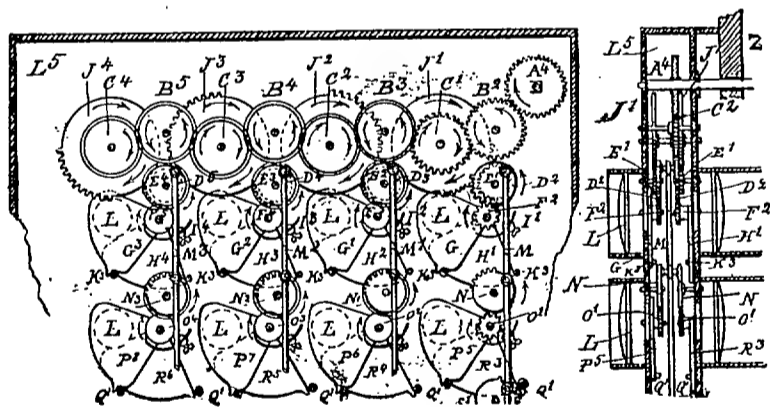

The process he employed consisted of passing strips of film behind four vertical rows of lenses, four lenses in a row, *i. e.*, sixteen lenses. The lenses in each row were exposed successively, the shutters

being released by means of mutilated gears. Each film, after the exposures were made upon it, was moved the width of these four pictures so as to bring a fresh surface of the sensitive film behind the lenses, this being done with each



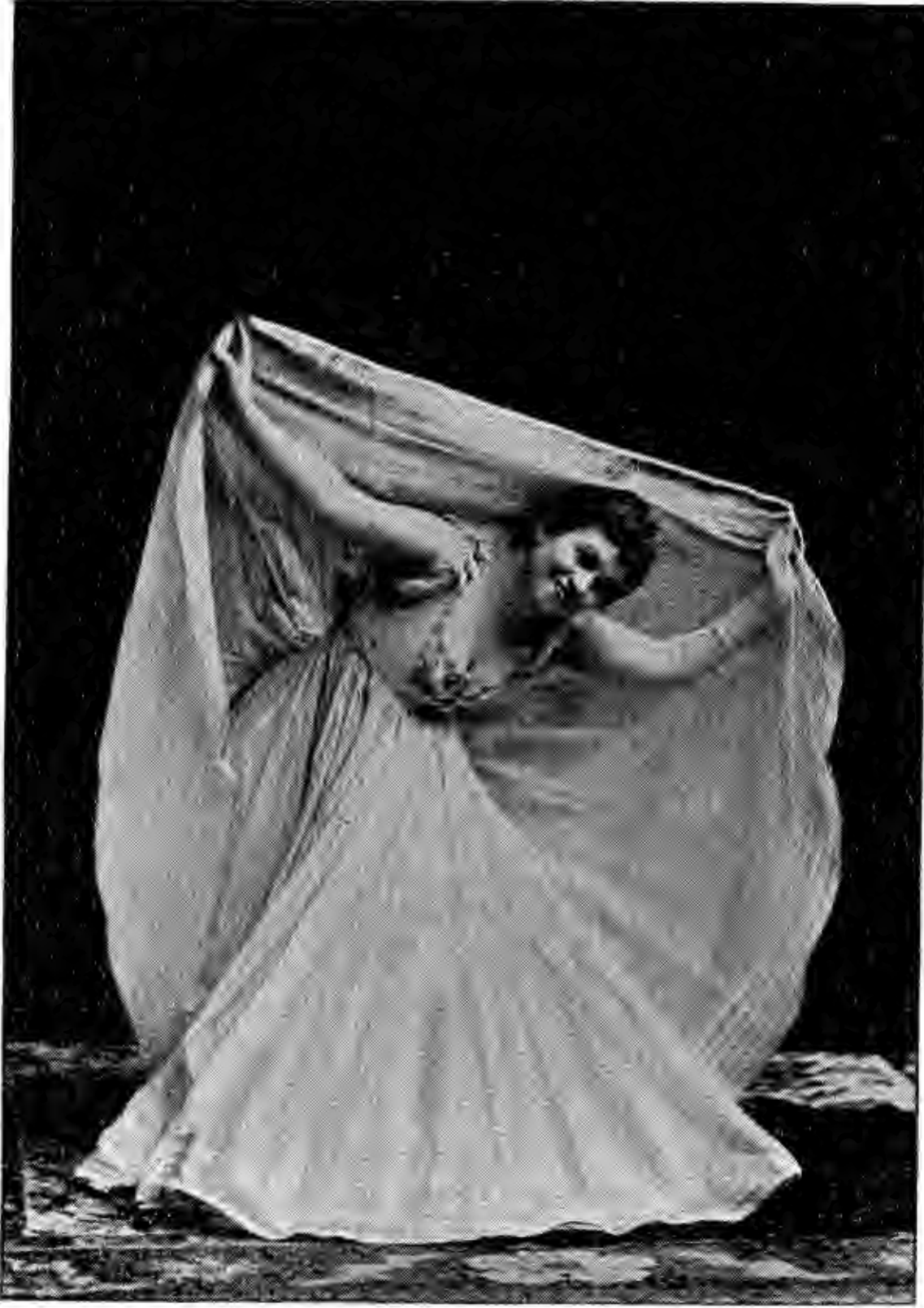

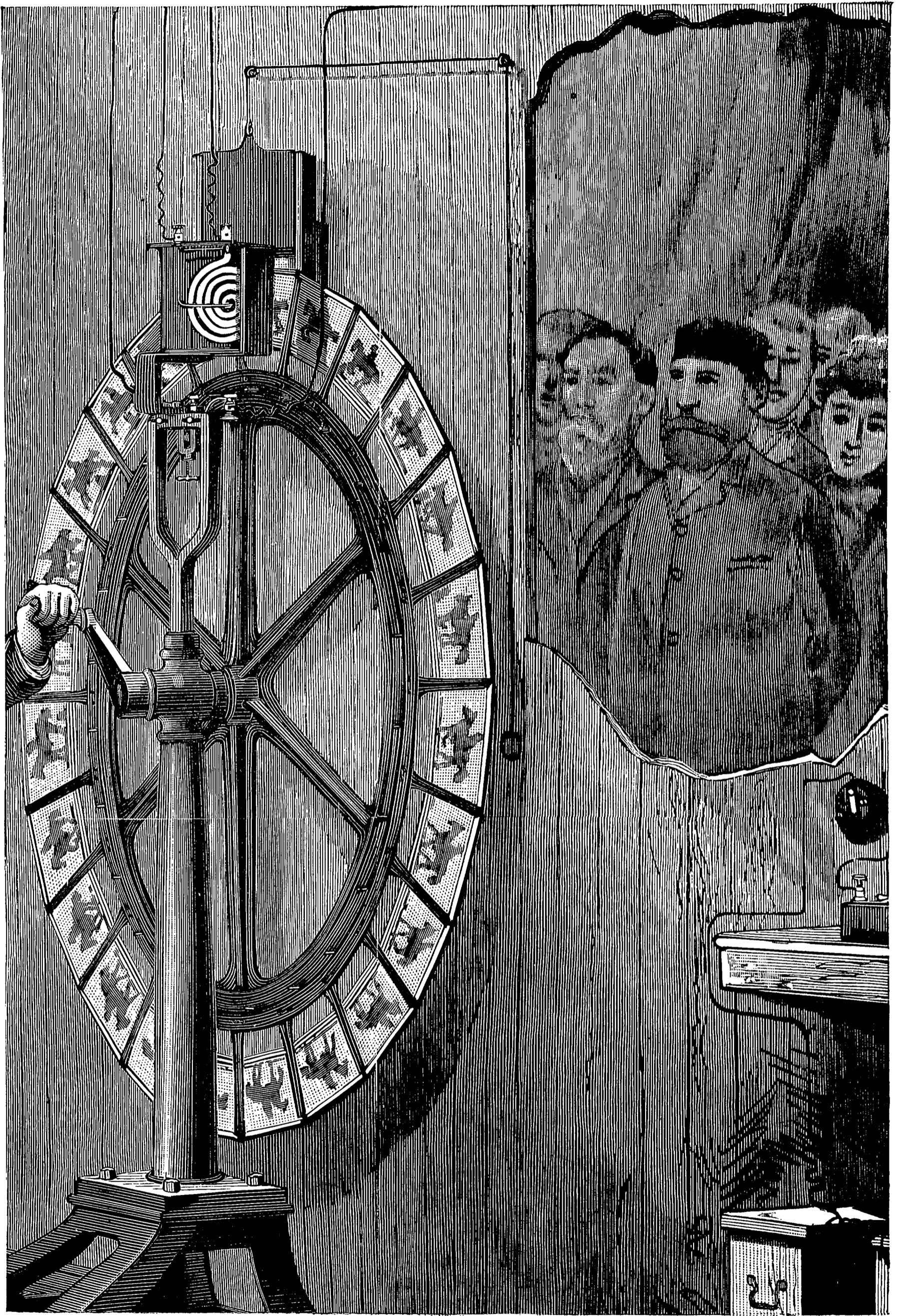

film while the exposures were being made on the other films in succession. Besides the perforated film, he also anticipated the coloring process now employed to enhance the beauty of the projected films. That his work did not come more prominently into notice was doubtless due to the complicated character of his "camera-projector," which had sixteen lenses, fitted with shutters and mutilated gears arranged to uncover the lenses in succession, and for illumination a full complement of lamps, one for each lens.

Levison in 1888 constructed an apparatus provided with sensitive plates mounted upon a drum capable of carrying them one after another into the focus of the objective. In his patent application, No. 578,249, filed June 26, 1888, he also shows and describes a modification of the same apparatus in which a ribbon is caused to move intermittently behind a lens. The film is drawn along by the friction of two plain rollers between which it passes. An intermittent motion is given to the rollers, by what he calls a "drunken screw." This is, a common worm a small part of which is parallel to the plane of rotation, and causes the engaging gear, to which the drums are fastened, to remain at rest for a moment at this point. At this instant the lens is suddenly uncovered to give the proper exposure. A description of the apparatus and method of operation appears in the *Brooklyn Daily Eagle* of June 14, 1888, and the *Citizen* of same date.

In 1889 Ancheutz published in the *Scientific American* his method of reproducing pictures in action, by means of his tachyscope. His sensitive plates were fastened around the periphery of a large disc or wheel upon which the photo-

graphs were made. From these negatives positives were printed. The disc which was fitted with make and break contact pins, one for each picture, was rotated, behind a sight-opening in a cabinet. As each picture came into position to be seen the contact pins, by the aid of an induction coil, sparked a vacuum tube which illuminated the picture. These illuminations, recurring with great frequency, gave the impression of continuous motion.

In a booklet published in 1895 and bearing Edison's "entire endorsement," his discovery (?) of the kinetoscope is thus described: "In the year 1887 Mr. Edison found himself in possession of one of those breathing spells which relieve the tension of inventive thought. It was then that he was struck with the idea of producing on the eye the effect of motion by means of a swift and graded succession of photographs. The initial principle of moving images was suggested to him by a toy, the zoetrope, or wheel of life. It was determined to revolutionize the whole nature of the proceedings by substituting a series of impressions, fixed to the outer edge of a swiftly rotating disc and supplied with a number of pegs, so arranged as to project under each picture. Under the rim a Geissler tube was placed, connected with an induction coil, which, operated by the pins, lighted up the tube at the precise moment when the picture crossed its range of vision." Later, about 1892, a different reproducing machine was employed, a device in which a film was used. This film, an endless belt, moves uniformly and passes through the field of a magnifying glass perpendicularly placed. The pictures as they pass are illuminated by a small incandescent lamp, the

view of them being cut off, however, by a rotating disc or shutter having a radial slit near its edge. The view of the picture is through this slotted disc, which covers and uncovers the pictures, revealing to the eye a new picture at each successive revolution. The views of these pictures recur with such frequency that an impression of movement is conveyed to the eye. These "picture ribbons are passed before the eye at the rate of forty-six pictures per second," presumably to commemorate the number of years which had passed over the head of the inventor, as there would seem to be no other good reason for it. The camera consists of a film-feeding mechanism, which permits the film to be started and stopped, the exposure being made while the film remains at rest, about thirty-five exposures per second the usual rate. The machine made its public debut June, 1894. A combination machine, a kinoscope containing a phonograph, has been more or less successfully introduced, rendering the moving picture together with music or other suitable sounds, giving the patron the pleasure of both seeing and hearing at one and the same time. The patent issued in Edison's name claims a stereoscopic projecting screen adaptation of the device, but it was not successful. The so-called Edison vitascope is not an Edison invention at all. This machine, under the name Phantoscope, was exhibited at the Cotton States and International Exposition, Atlanta, Ga., 1895, and was on March 17th, 1896, surreptitiously taken from the writer's residence, Washington, D. C. When the model machine was secured it was renamed the Edison vitascope and outfits were manufactured for rent only, territorial rights being offered at exorbitant prices. It was

not long, however, before the poor deluded purchaser learned to his chagrin that the sale was based upon no monopoly and that he had paid his good money for a little patch of blue sky.

The cinematograph, a '96 machine, by Lumiere, is a departure in film feeding mechanism, and very creditable results are produced. However, success is due more to the excellence of the picture ribbons than to the mechanism employed in feeding them. The film is fed through the light by hand and without sprocket wheels. The instrument may serve a three-fold purpose. First, it is a camera for taking the negative strip. After development, fixing and drying, etc., this negative strip is put film to film with another unexposed strip. The lens is removed and the opening pointed to a suitable light and the two films run through the instrument again. Number two developed yields a positive. The instrument is readjusted. A suitable light is placed at the back, and the pictures on the strip are thrown upon a canvas giving the familiar moving picture. The motion, brought about by an eccentric triangular movement, is of such a nature that "the film is still for just twice the time it takes to move it forward to occupy the space just vacated by its predecessor."

The American biograph and the mutoscope (also '96 machines) both very popular instruments, are the inventions of Herman Castler. In the biograph a film  $2\frac{3}{4}$  inches wide is employed, and the pictures are 2 inches high. The film is run without the use of sprocket teeth and in this way the full width of ribbon is available for pictures. The film is fed

forward by means of mutilated friction rollers and is intermittently stopped for the projection of each picture. A shutter is employed. The film is fed from a large drum upon which several thousand feet may be wound, and after passing in front of the lenses the film is carried to the rear of the machine, and automatically wound up on another drum. For this reason and also from the fact that the arc lamp employed is insulated from the rest of the machine,

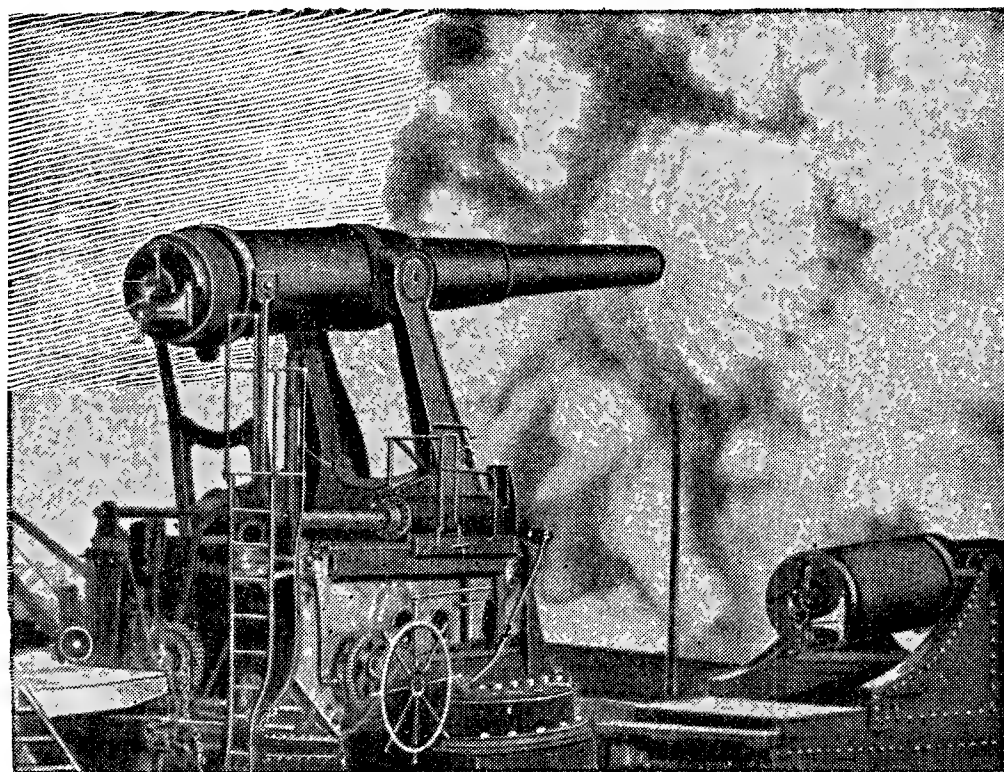

A BIOGRAPH PICTURE

there is no danger of setting the film on fire. The biograph is ordinarily driven by an electric motor. The friction feed permits the use of thinner film than is possible with sprocket feed. The use of thin film permits brighter illumination of the screen. A complete set of eight projecting lenses of different focus are furnished with each biograph in order that various pictures of any desired size may be thrown upon the screen, no matter what the distance between the screen and

the biograph. As the film is fed without perforations the register of the picture can not be automatic, but is accomplished by the operator, who during the entire performance must watch the screen, keeping his hand upon the small lever shown at the front of the machine. To secure accurate register before the picture appears a strip of dense film or "leader," with clear lines across it, is provided at the beginning of each picture ribbon. This accounts for the bright quivering line across the screen at the beginning of each picture exhibition. A tachometer is said to have been used at one time to secure the projection of the same number of pictures per minute as were photographed in the same length of time.

One of the simplest coin-slot picture machines which it has ever been the good fortune of the writer to examine is the mutoscope. This little instrument, not unlike a stereo-

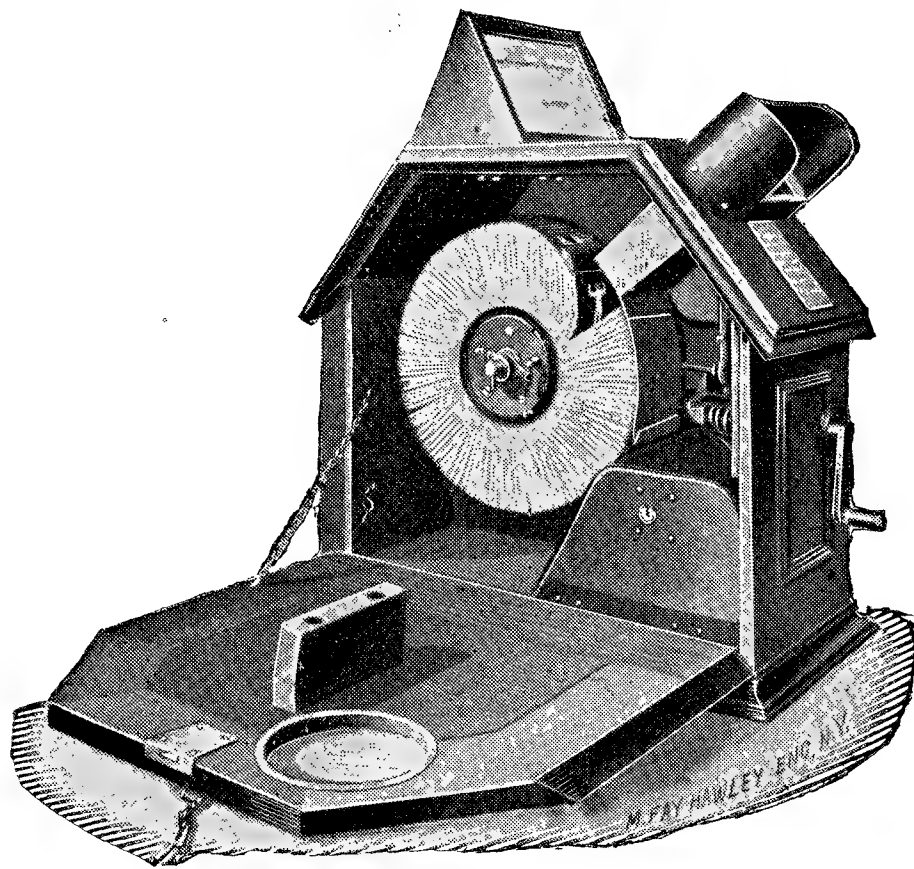

scope in general appearance, presents views of objects in motion, very life-like. Its mechanism is of so simple a character that it will not get out of order with reasonable use. It presents views about the size of an ordinary photo-

graph, and runs very smoothly. The negatives are made in



the usual manner, and from the series prints on paper are mounted in consecutive order around a cylinder standing out like the leaves of a book. When this cylinder is slowly revolved, the picture cards being held back by a stop, are allowed to snap past the eye one by one, as one thumbs the leaves of a book, and an apparently moving picture is the result. The cylinder or reel of pictures is mounted in a box on the outside of which is a crank. A very simple mechanism connects the crank with the cylinder when a nickel is dropped in the slot, thus allowing a person to make two complete rotations of the cylinder after which the crank is released, and another coin is required for another view. From nine hundred to one thousand pictures are mounted upon a cylinder. In operating the mutoscope the spectator has the performance entirely under his own control by the turning of the crank. He may make the operation as quick or as slow as fancy dictates, or he may maintain the normal speed at which the original performance took place; or, if he so elects, the entertainment can be stopped by him at any point in the series and each separate picture inspected at leisure; thus every step, motion, act or expression can be analyzed.

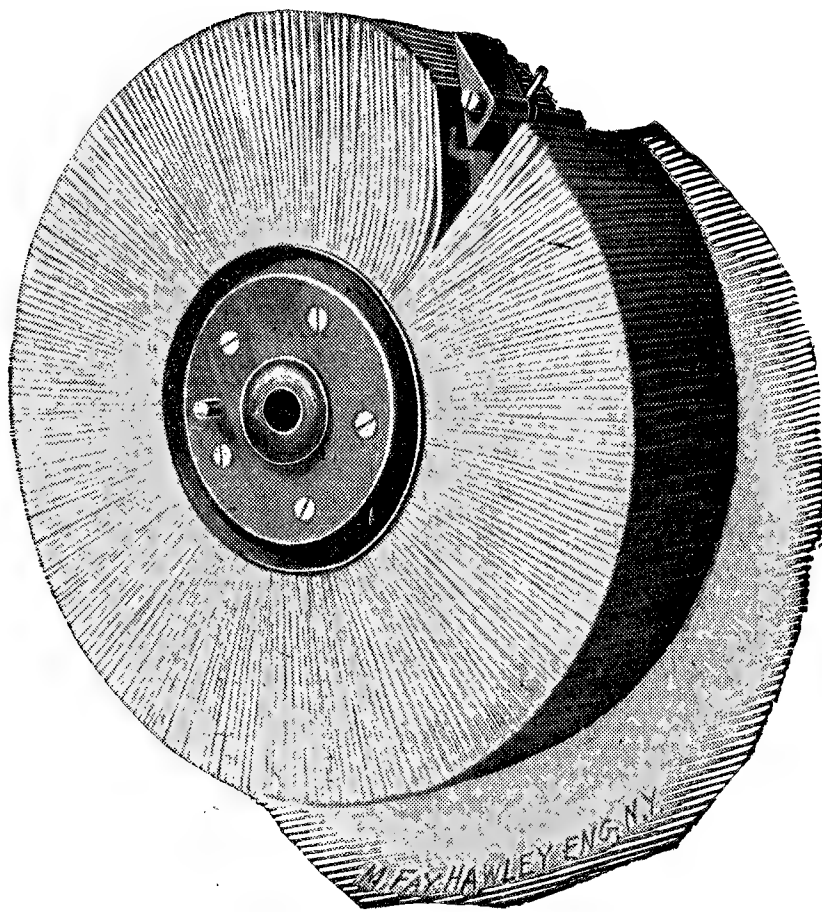

In 1896 there suddenly appeared a thumb-book, pocket edition of a mutoscope, which consisted of a simple pack of picture cards bound at one end in such manner that when one held the book between the thumb and fingers and let the cards or leaves slip from under the other thumb, quite a realistic picture of motion was produced. It is doubtless about as small a kinetoscopic apparatus as one is ever likely to see, a pair of hands being all the paraphernalia required to give a successful exhibition with a series of related pictures.

A novel device of the moving picture type consists of a segmental cylindrical lens revoluble in front of a single picture, and so arranged that on looking through it one sees the picture four times each revolution of the lens. The effect in the initial position is that of the object horizontally elongated; of the second position, vertically elongated; of the third position, horizontally elongated; and of the fourth position, vertically elongated again. The rapid rotation of the lens gives therefore a very comical effect, for instance, that of a face alternately laughing and crying.

There is a small and low-priced machine in which picture ribbons of paper are used, the view of the picture appearing in a reciprocating mirror. There is little of novelty in the method of exhibiting the picture, except, possibly, that the ribbon is fed without perforations. The preparation of the paper ribbon is interesting, however.

A negative is made in a camera similar to the ordinary chronophotographic cameras feeding the film either with or without perforations. This long strip of film is developed

and dried, afterwards being cut into short lengths which are cemented, side by side, upon a permanent support. From a positive of this, negatives are made through a screen and half-tones etched therefrom. From these half-tone blocks the pictures are printed in large sheets on heavy surfaced paper. Afterward the vertical rows of pictures are cut apart and pasted together, forming a long, endless band of paper carrying on its surface a series of related pictures. The reproducing machine is so constructed that the ribbon can be put into the machine whole, that is, the ribbons are interchangeable.



LIST OF "SCOPE" AND "GRAPH" MACHINES  
WHICH HAVE ALREADY APPEARED.

|                 |                        |                    |
|-----------------|------------------------|--------------------|
| Phantoscope     | Rayoscope              | Vileocigraphoscope |
| Criterionoscope | Motiscope              | Pantomograph       |
| Biograph        | Kinotigraph            | Ammotiscope        |
| Cinematograph   | Phenakistoscope        | Acheograph         |
| Vitascope       | Venetropes             | Kinographoscope    |
| Kinematograph   | Vitrescope             | Lifeoscope         |
| Wondorscope     | Zinematograph          | Sygmographoscope   |
| Animatoscope    | Vitopticon             | Kineoptoscope      |
| Vitagraph       | Stinnetiscope          | Cieroscope         |
| Cosmoscope      | Vivrescope             | Velograph          |
| Anarithmoscope  | Daramiscope            | Stereoptigraph     |
| Panoramograph   | Lobsterscope           | Eragraph           |
| Katoptukum      | Corminograph           | Moto-Photoscope    |
| Magniscope      | Kineoptoscope          | Zoopraxiscope      |
| Zoeoptotrope    | Scenamotograph         | Tachyscope         |
| Phantasmagoria  | Kineograph             | Thaumototrope      |
| Projectoscope   | Thromotrope            | Thropograph        |
| Variscope       | Kinebleboscope         | Mimicoscope        |
| Cinograph       | Pictorialograph        | Musculariscope     |
| Cinnemonograph  | Kinegraphoscope        | Involograph        |
| Hypnoscope      | Vileograph             | Shadographoscope   |
| Centograph      | Kinevitograph          | Counterfivoscope   |
| X-ograph        | Photokinematoscope     | Realiphotoscope    |
| Electroscope    | Kinesetograph          | Rythmograph        |
| Cinagraphoscope | Mophotoscope           | Photoscope         |
| Kinetoscope     | Phototrope             | Originagraph       |
| Craboscope      | Movementoscope         | Persistoscope      |
| Viletoscope     | Touniatoscope          | Selfseminograph    |
| Cinematoscope   | Vilophotoscope         | Getthemoneygraph   |
| Mutoscope       | Waterscope             | Parlorgraph        |
| Cinoscope       | Visionscope            | Phasmatrope        |
| Animaloscope    | Phonendoscope          | Klondikoscope      |
| Theatograph     | Lumiograph             | Stroboscope        |
| Monograph       | Heliographoscope       | Chronomatograph    |
| Motorgraph      | Pantobiograph          | Scenoscope         |
| Kineatograph    | Zoetrope               | Tropograph         |
|                 | Chronophotographoscope |                    |

## THE PHANTOSCOPE.

**B**EFORE commencing a sketch of my own work along this line, I think I may be pardoned for saying that, prior to my demonstrating and pointing out the absolutely essential principles to be embodied in successful projecting machines, *i. e.*, that the pictures must be moved in such manner that the interval of illumination shall exceed the period of movement, change or substitution of the pictures in the series, there was not a machine (other than my own) in existence which would give illumination to these pictures on a large screen; and also that all machines constructed since the publication (1894) of this demonstration embody the principle, explained and claimed in an application for a United States patent, serial No. 570,010. That this discovery brought the work to a commercially practical basis, is evidenced by the fact that since the publication of the details of my methods (*Photographic Times*, May, 1896) machines of this kind have sprung up like mushrooms in a night, and three times as many patents have been issued thereon in two years since that time as were issued in thirty years prior to the publication referred to.

That they may serve as guide-boards pointing out those things to avoid as well as suggesting those to adopt in the best solution of the problems involved in the construction of

chronophotographic apparatus, is the incentive for presenting the following description of my experiments, many of which were conducted for educational advantages they afforded me. That this experimentation was dependent upon what could be spared out of a small salary must be my excuse for the delay in completing a commercial machine after the first conception of the Phantoscope, which is simply a fanciful name for the various devices I have employed in this work, the different steps of which may readily be followed by an inspection of the old apparatus now on exhibition in the United States National Museum.

In 1885, while standing one day on a high prominence in the Cascade Mountains, I watched the reflections of sunlight from the axes of some workmen clearing a right-of-way for a railroad in the valley several miles below. The reflections from two or three hundred axes produced a peculiar scintillating and very pretty effect. From that moment I date all my efforts to achieve what finally resulted in the perfection of the chronophotographic apparatus I have built and used.

My active experiments were begun in 1890. Of course, first of all pictures were to be secured. The first apparatus built for this purpose consisted of a ratchet-rotated drum upon which the film was wound to feed it past the point of exposure. The camera made a succession of pictures upon this film by short exposures, the film being jerked forward the width of one picture in the interim. Two shutters were supplied, one with a narrow opening employed when the apparatus was used as a camera, and the other having an opening three-fourths of the complete circumference of the

disc employed in reproducing the pictures. The amount to cut away in the shutter was determined wholly by experiment. The film was wound upon the drum intermittently by means of a pawl and ratchet movement. In reproducing the pictures an oil lamp was used to project them upon a small screen.

By accident, the camera was found to be so constructed that it would make discrete pictures without a shutter. This seems at first glance incredible, but as the film gets only just sufficient exposure during the period of rest, the light is too weak to affect it during the movement of the film, for if five pictures per second were made and the exposure exceeded by fifteen times the time necessary to move an unexposed portion of the film into position, and the period of exposure should be just sufficient to make a fully-timed picture, then the remaining  $\frac{1}{300}$  part of a second would be too small to perceptibly affect the film and a shutter would be unnecessary.

In these early experiments the film was not perforated. At this time the manufacturers did not keep a stock of film of any width in considerable lengths. This convenience came later. So the longest film obtainable was split into widths of about  $2\frac{1}{2}$  inches by drawing wide film beneath knives set in a board.

The advantages of a constantly moving film were soon very manifest. At this time there was no known way whereby pictures could be photographed upon a moving negative. It is, however, the only thoroughly practical way to make a flexible instrument, one capable of making a great number of

pictures per second. By a sort of intuition I decided that if the light from the object being photographed was caused to travel downward at the same speed as the film, that is, so that it should not (until cut off entirely) depart from the position it occupied when it first impinged upon the film, the result would be a sharp, properly-exposed picture. A camera was designed and constructed in which lenses of the same focus were caused to rotate about a common axis. By means of proper gears, etc., the film was caused to travel at the back of the camera in the same direction and in exact synchron-

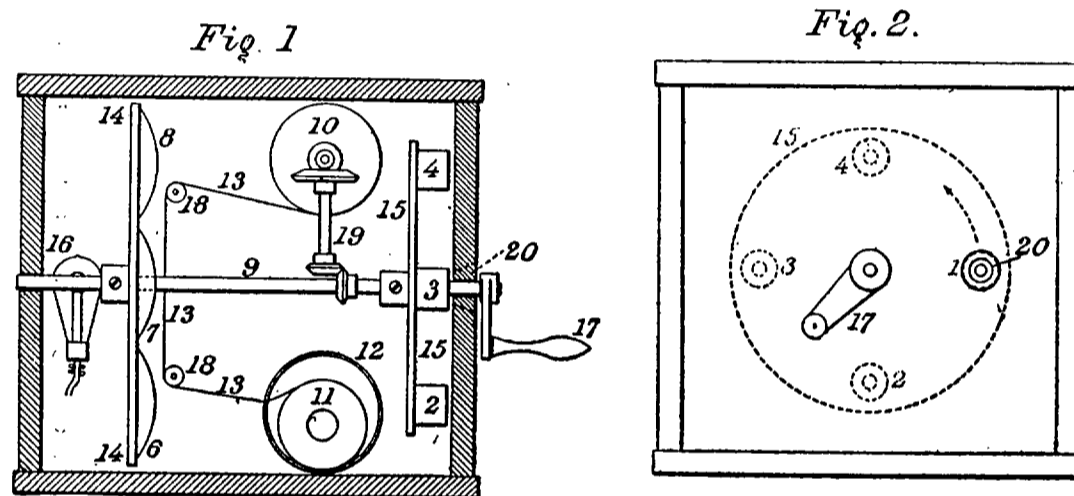

JENKINS' ROTARY LENS CAMERA.

ism with the motion of the lenses. As each lens passed an opening in the front of the box it would transmit momentary images to the moving sensitive film, and as the film was constantly wound upon the drum each picture was taken in a new place upon the film. The lenses travel in an arc of a circle, to be sure, but the opening is so small, as compared with the lens circle, and the arc so nearly coincides with a straight line that this feature is not detrimental, neither is the fact that the negative and the lenses are at slightly different distances from the subject. The result of continued opera-



tion was a length of negative film with similar pictures thereon, each picture differing slightly from the preceding one owing to the constant movement of the object photographed. This machine was the first ever built in which the film was caused to travel constantly and in synchronism with constantly moving lenses. Both bands and discs were used to carry the lenses, each presenting certain advantages.

These two distinctive and exactly opposite methods, namely, the one employing an intermittently moving film and the other a constantly moving film, have been elaborated side by side and many and varied the devices built for the purpose.

The second machine built employing intermittent motion consisted of a crankhead with an eccentrically located drum or spool fastened thereto to which the end of the film was fastened and upon which it was wound by the rotation of the crankhead. This gave the required intermittent or stop and start motion of the film, although the stopping and starting of the film was prepared for by a gradual diminution and acceleration of the velocity, respectively.

The second rotary camera-projector consisted of a device of five lenses, making a picture  $2\frac{1}{2}$  inches square. The camera had detachable light-proof film boxes, serving the same purpose that plate holders do in an ordinary camera. As in the first camera, a revoluble diaphragm was mounted between the rotating lenses and the opening in the box.

With this rotary camera I could record the number of photographs taken in a single unit of time, and thus easily and accurately determine the sensitiveness of chemicals, the

strength of light and the rapidity of lenses. A simple way of doing this was to drop a white ball along a graduated scale before a dark cavity as a background. Photographs taken during its descent gave the desired record.

Another form of feeding mechanism, used in some forms of fabric machines for feeding the web, consisting of two rolls running together, one of which is cut away for, say, three-fourths its circumference, was made for feeding unperforated film. It will readily be seen that the "bite" for traction comes only when the co-incidental surfaces press against each other, and that at other times the film stands still, although the rollers continue to revolve.

Still another form which I used only as a camera consisted of a crankhead connected by a pitman to a bellcrank. The latter was fulcrumed on a grooved block sliding on ways. Now there was such frictional resistance to the sliding of the block on the ways that the first action of the pitman caused the sharp teeth of the bellcrank prongs to stick into the unperforated film and pull it down, when it was released and the bellcrank returned with the return of the block.

A cabinet device, into which the customer looked, with the film moving uniformly, was constructed in 1893 and earned more than \$55 in nickels in two weeks' public exhibition. The picture was illuminated by flying lights passing quickly beneath the film when each picture came into proper position to register with the preceding picture when seen. Illumination lasted of course for a very brief instant. The machine was fitted with an automatic device for timing the view before cutting off the current to the driving motor.

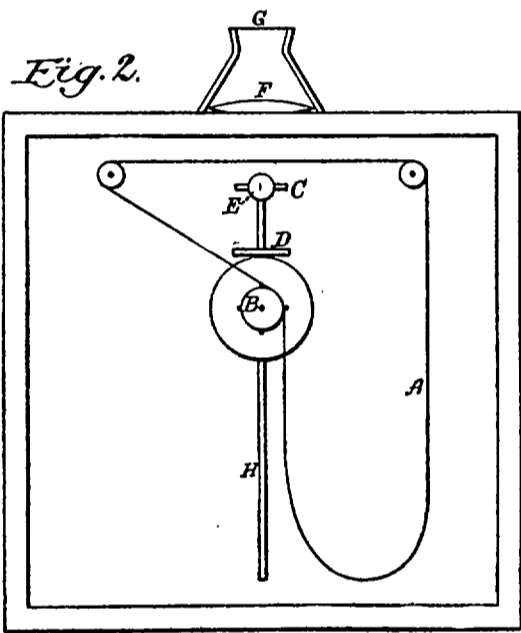
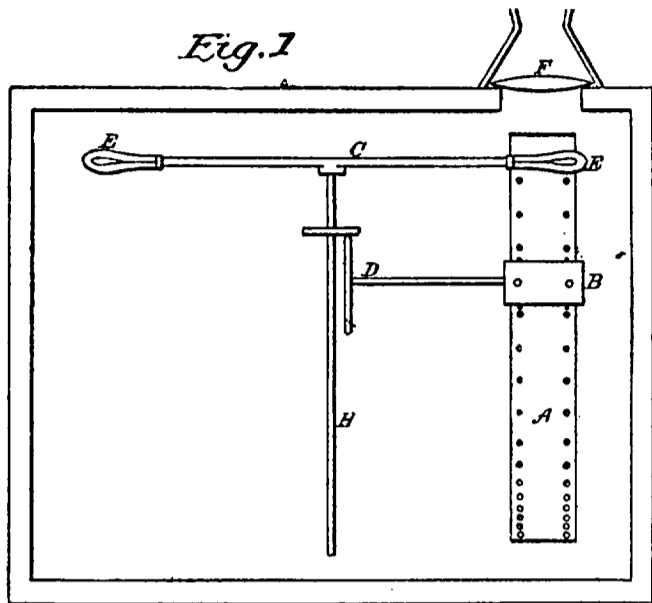

JENKINS' EARLY FORM OF CABINET—INTERMITTENT ILLUMINATION.

Another, a projecting machine, a compromise between constantly moving and intermittently moving film, employed in its construction a pair of elliptical gears which gave to the film a very quick movement at one period of the feed followed by a period of comparatively slow movement at the moment of projection. It was abandoned as being too noisy.

The next machine employed intermittent gears and a toothed drum for feeding the film. The illuminant used was an electric lamp. The drum was so large and heavy that the gears finally broke down. It did, however, again and

conclusively prove that my original idea of a projecting Phantoscope was correct. The instrument depends for its successful operation upon that faculty of the eye which permits of but one impression on the retina at a time. This seems never before to have been taken advantage of in the construction of these machines. The invention proper consists of a simple mechanism for feeding a picture carrying tape across the optical axis of the projecting lens of an ordinary lantern. No shutter is employed, but the instrument

is so constructed and operated that each picture is held stationary in the optical axis of the projecting lens for, say,  $\frac{1}{12}$  of an interval, and is changed, that is, another picture is substituted, in the remaining  $\frac{1}{12}$  of an interval. Or, in other words, if twenty-five pictures per second are being projected (which is quite enough) each picture is held stationary in the axis of the lens  $\frac{1}{12}$  of  $\frac{1}{25}$  of a second, and is fed forward the width of one picture in the remaining  $\frac{1}{12}$  of  $\frac{1}{25}$  of a second. The impression which the picture makes on the eye, is, therefore, more than ten times as strong as that of the movement, and consequently, as the eye can not distinguish two impressions, but perceives only the stronger, the substitution of the pictures is not perceptible. The film is held, during exposure, in the projected light between two tension members to prevent flexure. The only problem to be solved was that of the best mechanism to adopt for feeding the film.

A disc with peripherally arranged pictures was constructed, which, afterward, to increase the number of pictures carried on each disc, was so modified as to permit the pictures being arranged spirally on the plate.

The second cabinet built contained a stationary light which constantly illuminated the ribbon, the latter moving uniformly. The pictures were viewed in mirrors which rotated in such manner that the eye followed each picture for a distance of about three-fourths or four-fifths of the length or height of the picture. Thus the constantly moving picture appeared to remain stationary, and the repeated rotation of the mirrors caused the pictures to blend into one. A projecting machine built on this principle is working nicely.

For use in the construction of the next machine the crank-head was taken from the old box camera-projector and used to pull down the film through the tension, discontinuously, while the slack was taken up each time by means of a toothed sprocket (employed to direct its movements) so as to pull a picture into position to be projected. As each picture attains this position the traction ceases and it is momentarily arrested. Here it remains at a standstill for a period four or five times as long as it took to move into position, after which the picture again resumes its journey, while its successor in the series is brought to a similar fixed position. At the instant it stops a portion of the film on the preceding side of the picture will be slack. This slack is then taken up by a continuous rotating sprocket whereupon an eccentric element quickly bears against the now tightened ribbon, pressing it downward and again quickly releasing it. By this movement the next picture is pulled into position while the film is made nearly taut on the following side of the picture. This recurs, of course, twenty-five or more times per second, until the entire series has passed the lens. The striking of the eccentric element on the film is the cause of the continuous "snapping" noise noticeable in the Phantoscope (and vitascope, the same rose by another name, the model for which was surreptitiously taken from the writer's residence, March 17, 1896, as before stated). Heat absorbent cells were introduced to take up the calorific rays. None of the mechanism has a jerky or intermittent movement, and no mass in motion comes to a standstill. All parts of the mechanism have uniform continuous rotary motion, and the stoppage of the

film is provided for by a gradual diminution of the velocity, and so, too, the starting is effected without any abruptness. This was the machine constructed for use at the Cotton States and International Exposition, Atlanta, Georgia, 1895, since which time "scope" and "graph" at the end of any word is considered by the public generally as synonymous with moving picture machines, although at that time understood or appreciated by but few, the few who casually visited the Phantoscope building.

The camera used for making films for this machine consisted of mechanism similar to that used in the projecting machine and fitted with a shutter and driven by an electric motor, the whole encased in a light-tight cherry box. The film was drawn from the supply roll past the point of exposure and wound upon another spool. At the point of exposure, the film, which was about  $\frac{3}{1000}$  of an inch in thickness, had nothing behind it for twenty-eight inches, and yet several times I developed a film of eighteen hundred pictures in which each picture showed so much halation that the entire film had to be thrown away.

A novelty belonging to the intermittent variety, consisted of a sprocket eccentrically mounted upon a balanced crank-head. To prevent the sprocket teeth cutting the film as they stepped in and out of the holes it was necessary to make the sprocket large enough to hold two pictures, that is, the circumference should be  $1\frac{1}{2}$  inches. Now if the sprocket was rigidly fastened to the crankhead it would pull two pictures down at each revolution, so a light two-inch gear was cast upon one end of the sprocket and the latter loosely

mounted upon a pin on the crankhead, the gear meshing in an internal gear of three-inch pitch diameter, which caused the sprocket to turn half a revolution backward at each revolution of the crankhead. It is a decided novelty in this line and possesses some advantages worthy of special adoption.

The next camera built was a rotary in which a shutter was employed. It contained fifteen lenses. Now all of the

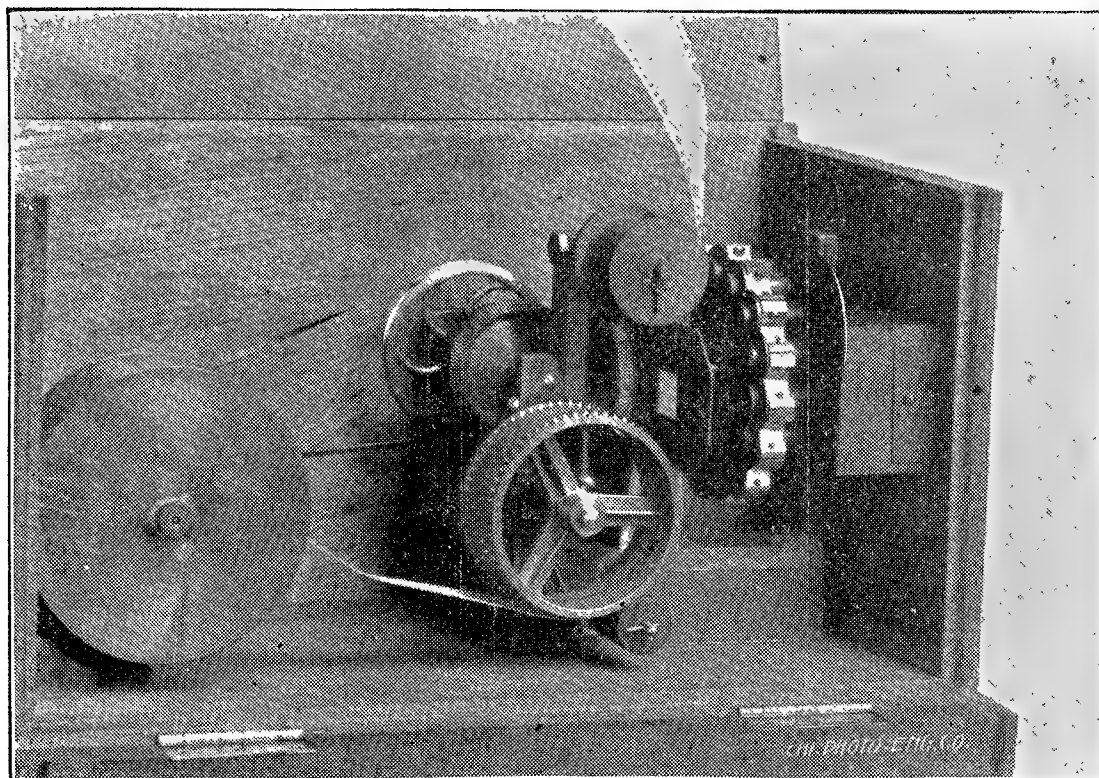

JENKINS' ROTARY LENS CAMERA.

traveling-lens cameras heretofore built had shown a slight fuzzy line between the pictures. The addition of a shutter effectually remedied this and enabled me, by using a balanced shutter, to make above two hundred and fifty discrete, fully-timed pictures per second, and a rate of a thousand pictures per second is not an impossibility. In fact, the number of pictures per second that this camera is capable of making is almost unlimited if the subject is properly illuminated, for it

will be observed that if this camera be operated at the rate of a thousand pictures per second each picture will receive an exposure of a corresponding fraction of a second, *i. e.*, one thousandth of a second.

As making sharply-defined, fully-timed, discrete pictures upon a constantly-moving negative is a new contribution to scientific photography, I will again describe the method, even at the risk of seeming lengthy. At the back of the camera an unexposed negative film is adapted to be fed, say vertically, at a uniform rate. Now if the light reflected from the object being photographed is caused to travel downward at the same speed, that is, so that it shall not (until cut off entirely) depart from the position it occupied when it first impinged upon the film, the result will be a sharp, properly-exposed picture. This is accomplished by mounting several like lenses on a disc or band and revolving them so that each shall pass an opening in the front of the camera. The light passing through each lens impinges upon the negative and travels with it until the lens has crossed the opening, in an arc of a circle, to be sure, but the opening is so small and the arc so nearly approaches a straight line that this is not detrimental, neither is the fact that the lenses and the negative are at slightly different distances from the subject. It would overexpose before it would blur from displacement. When the opening is so large as  $\frac{1}{4}$  inch the ray of light will not change its position on the negative more than .00625 of an inch. This is, of course, inconsequential, and the picture is sharp and clear. The opening is diminished or increased as it is intended that the pictures shall be taken



with greater or less rapidity, say, from fifteen to one hundred and fifty per second. The other cause of displacement comes from the difference in the positions of the lenses and negative, thus, if the object is one hundred feet away and the opening is  $\frac{1}{4}$  inch, and from the lens to the negative is three inches, then the departure of the ray of light from its predetermined position consequent upon the angle through which it moves is about .0015 of an inch, also negligible. I presume it would be possible to construct a camera in such a way that the lenses would move more slowly than the film so as to compensate for this, but it is not worth the effort. Traveling prisms and mirrors may be substituted for the lenses and are found to fulfill all conditions, though not so conveniently. As will readily appear there are many advantages to be derived from employing uniform motion in a camera taking pictures so rapidly.

A third cabinet exhibitor was built, the mechanism of which was in reality a miniature projecting machine. The cabinet contained an electric lamp, a motor, a film-feeder and support and a lens and prism for projecting the pictures upon a white plate twelve inches square in the bottom of the cabinet. The rapid repetition of the illumination gave a continuous impression instinct with mimic life.

A coin-actuated picture device, used on the Boardwalk, Atlantic City, season of 1896, consisted, as shown, of a black, light-tight cabinet, the front of which was fitted with twelve peep-sights or sight openings. The cabinet was 18 feet front and 12 feet deep, and was divided into three compartments. In the back of each compartment was a white

screen 6 by 8 feet, upon which the machine threw life-sized pictures. The machines were electrically driven and were located on tables behind the cabinet where the operator could attend them without in any way interfering with the projection of the pictures. The light was projected into the cabinet through an opening in the edge of the screen in the



JENKINS' SLOT-ACTION CABINET—LIFE-SIZE PICTURES.

back of the cabinet. This arrangement, with specially-designed projecting lenses, gave a picture covering a 6 by 8 foot canvas in a space of but 12 feet, with a picture slide of  $\frac{3}{4}$  inch in the machine, an accomplishment in lantern work worthy of mention. The machines were entirely automatic throughout, starting, timing, and stopping without

assistance. The slot actions were dependent and independent of each other; that is, when a customer put in a nickel coin the machine in that cabinet was started automatically and continued to run for forty seconds when, provided no other nickels were deposited, the machine would stop. If, however, while the first customer was watching the picture, other cus-

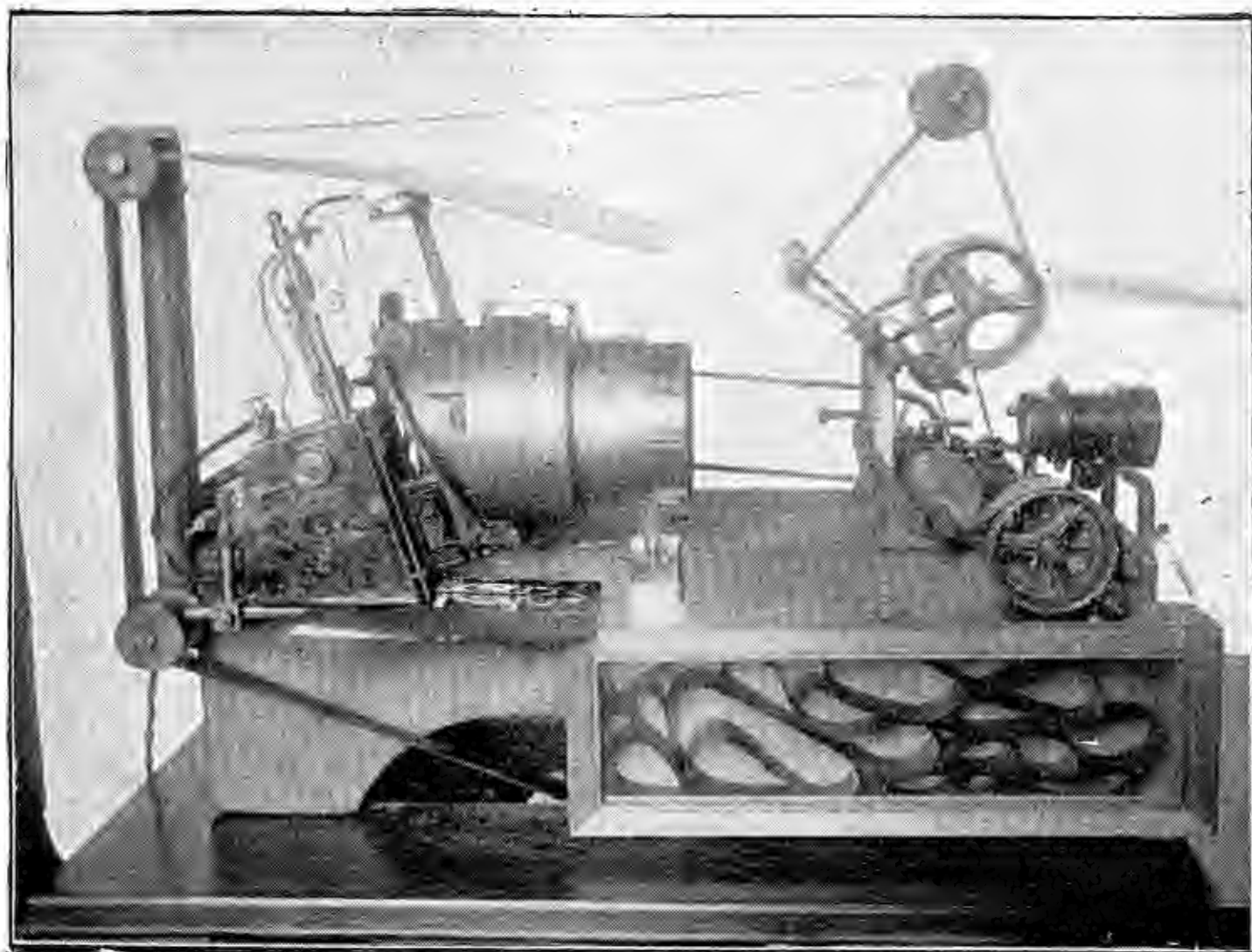

A LATER FORM JENKINS PROJECTING PHANTOSCOPE.

tomers patronized the same machine by putting in other nickels each would be accommodated with a forty-second exhibit, no more and no less, the view of each being cut off just forty seconds after he deposited his nickel.

This machine had film tanks to hold the surplus film of the endless band used. This film tank has proven a device

of uniformly good results, and not a single torn film has yet been chargeable to its use.

The ultimate outcome of experiments to make moving-picture apparatus as an attachment for ordinary magic lanterns is the very simple piece of mechanism shown, being an attachment for a J. B. Colt & Co.'s lantern. The picture

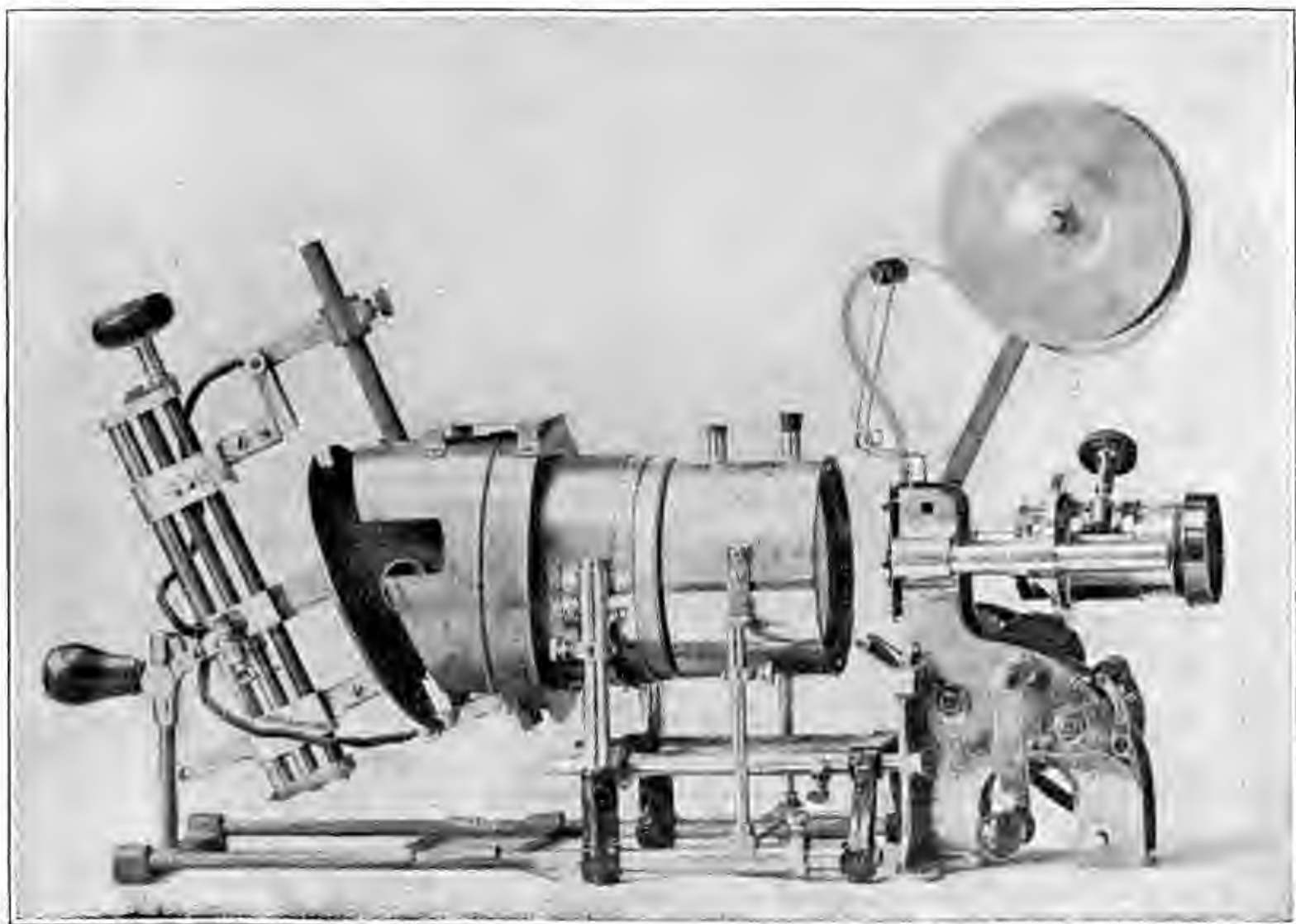

ribbon is fed across the light by turning a crank. The motion of the crank is sufficiently uniform for proper reproduction on the screen, and possesses some considerable advantages, not the least of which is the fact that the proper speed for each particular subject can readily be applied to the feeding of each of a great variety of subjects which were

previously taken at, probably, as many different speeds of camera crank. The change from lantern to moving-picture machine and vice versa is the work of but a moment.

Another rotating projecting attachment for a Colt lantern consists of a lens-carrier and a sprocket mounted upon the same shaft. There was no gearing of any kind whatever in this apparatus, the shaft being set askew to the optical axis of the lantern. It ran with absolutely no noise and was the acme of simplicity.

The next projecting machine embodied the traveling lens principle and consisted of a band upon which were mounted nine  $\frac{1}{4}$ -size objectives. These were caused to travel downward in exact synchronism with the film, which, by means of a toothed sprocket, was drawn from the spool or reel at the top, down between two plates, which did not, however, press upon the film, but formed a channel in which the film remained flat and free of vibrations in the focus of the objectives. These lenses were so located that each was projecting a picture before the preceding lens ceased to project the picture it covered. Each consecutive picture is projected by a separate lens, *i. e.*, only every ninth picture is projected by the same lens. As the lens crosses the beam of light it is followed closely by another which begins immediately to project the picture it covers, and thus are the two pictures superposed upon the screen, one fading while the other is nearing its maximum illumination. This machine does not depend in the least upon persistence of vision for its successful operation, and no matter how slowly the machine is driven the eye will still see a picture, though the

proper blending of the pictures to give smooth continuity of motion requires that the machine project fifteen to twenty-five pictures per second.

That the above theory is correct can readily be determined by loosening both the objective and slide carrier of an ordinary magic lantern and sliding them up and down together. If the lens is moved down, down goes the picture on the screen; if the picture is moved down, up goes the projected picture on the screen; if both lens and picture go down together the projected picture stands still on the screen.

A combination camera-projector, lately constructed, feeding a  $2\frac{3}{4}$ -inch film intermittently and without perforations and also without the employment of gears of any kind, promises to be the most satisfactory machine yet constructed. It is noiseless, has no vibration, and runs with great smoothness. Machines of this character, that is, machines for feeding wide film without perforations, are standard machines of the future; it may be a year, it may be more, but all machines will use large pictures sooner or later,—it is the only correct method.



## References in the Art of Moving Pictures to the date of the description of the first successful projecting machine in May of 1896.

### Serial Pictures (other than on Bands).

British pat. No. 1,457, 1861.  
 American pat. No. 64,117, 1867, Lincoln.  
 American pat. No. 41,117, 1868.  
 American pat. No. 93,594, 1869, Brown.  
 "Student and Intellectual Observer," Vol.  
 2, 1869, Plateau.  
 American pat. No. 132,676, 1872, Layman.  
 British pat. No. 100, 1874, Ray.  
 American pat. No. 171,986, 1876, Burdett.  
 American pat. No. 174,206, 1876, David.  
 American pat. No. 183,550, 1876, Earle.  
 American pat. No. 184,847, 1876, Curtis.  
 British pat. No. 4,244, 1877, Reynaud.  
*Scientific American*, Oct. 19, 1878.  
*Scientific American Supt.*, Jan. 11, 1879,  
 Muybridge.  
 American pat. No. 212,865, 1879, Muybridge.  
 American pat. No. 237,389, 1881, King.  
*Photo News*, Vol. 26, p. 173, Mar. 31, 1881,  
 Muybridge.  
 German pat. No. 71,339.  
*Scientific American Supt.*, June 10, 1882,  
 Marey.  
 American pat. No. 259,950, 1882, Haven-  
 bergh.  
 American pat. No. 279,878, 1882, Muybridge.  
*Photo News*, Vol. 26, p. 443, July 28, 1882,  
 Marey.  
*Franklin Institute Journal*, April, 1883.  
*French Scientific Society Journal*, June 28,  
 1883.  
*Scientific American Supt.*, Oct. 27, 1883,  
 Marey.  
*French Scientific Society Journal*, May 12,  
 1885.  
*Scientific American Supt.*, Feb. 5, 1887, Marey.  
*Scientific American Supt.*, Feb. 12, 1887,  
 Marey.  
*French Scientific Society Journal*, Oct. 15,  
 1888.

*Scientific American*, Sept. 21, 1889.  
*Scientific American*, Nov. 16, 1889.  
 British pat. No. 15,709, 1892, Demeny.  
 German pat. No. 57,133, Kohlrausch.

### Single Film Apparatus Shown.

American pat. No. 27,572, 1860, Lee & Sealey.  
 American pat. No. 31,357, 1861, Sellers.  
 British pat. No. 4,344, 1876.  
*Nature*, Vol. 17, p. 242, 1878, Donisthrope.  
*Scientific American Supt.*, Jan. 11, 1879,  
 Muybridge.  
 British pat. No. 2,271, 1879, Brewer.  
*La Nature*, Apr. 22, 1881, Marey.  
*Photo News*, Nov. 10, 1882, Reynaud.  
*Die Movement Photographie*, 1886, Eder.  
 British pat. No. 6,673, 1887, Boulton.  
 British pat. No. 9,807, 1887, Schroyer.  
*Brooklyn Eagle*, June 14, 1888, Levison.  
*Brooklyn Citizen*, June 14, 1888, Levison.  
 British pat. No. 2,375, 1888, Edwards.  
 British pat. No. 393, 1889, Littler.  
 British pat. No. 10,131, 1889, Green.  
 British pat. No. 504, Jan. 10, 1889, Morris.  
 German pat. No. 56,503, 1889, Green.  
 British pat. No. 17,070, 1889, Meyer.  
 Italian pat. No. 221,444, 1889, Green.  
 British pat., Aug. 15, 1889, Donisthrope.  
 British pat. No. 6,353, 1889, Darier.  
*Magic Lantern Journal and Photo Enlarger*,  
 Nov. 15, 1889.  
 British pat. No. 3,730, 1890, Evans.  
*Magic Lantern Journal and Photo Enlarger*,  
 April 1, 1890.  
 British pat. No. 4,704, 1890, Varley.  
*French Scientific Society Journal*, Nov. 3,  
 1890.  
*Scientific American Supt.*, Apr. 19, 1890,  
 Evans.  
*Scientific American Supt.*, Mar. 22, 1890.  
*Scientific American Supt.*, Mar. 29, 1890.

British pat. No. 4,956, 1890, Green & Varley.  
 American pat. No. 452,966, 1891, Donisthrope & Croft.  
*French Scientific Society Journal*, July 6, 1891.  
*Electricity*, June 6, 1891.  
*Globe* (London), June 10, 1891.  
*Electricity*, Aug. 1, 1891.  
*Scientific American Supt.*, Jan. 10, 1891, Marey.  
 American pat. No. 459,140, 1891, Kronenberg.  
*Electrical Engineer*, Vol. 11, p. 708, 1891.  
*La Revue de Sciences*, Nov. 15, 1891.  
 French pat., June 2, 1893, Marey.  
 "Zoopraxography," 1893, Muybridge.  
*Scientific American Supt.*, June 18, 1892.  
*Scientific American Supt.*, July 23, 1893.  
*Die Movement Photographie*, 1892, David & Schlik.  
*Scientific American*, Dec. 30, 1893.  
*Scientific American Supt.*, Oct. 27, 1894.  
*Scientific American Supt.*, Dec. 15, 1894.  
*Telegram* (Richmond, Ind.), June 6, 1894.  
*Photographic Times*, July, 1894.

**The Use of Endless Band Shown.**

British pat. No. 537, 1860, Desvignes.  
 American pat. No. 31,357, 1867, Sellers.  
 British pat. No. 3,700, 1881, Cooper.  
 British pat. No. 377, 1884, Hayes & Whelden.  
 British pat. No. 9,807, 1887, Schroyer.  
 British pat. No. 2,375, 1888, Edwards.

British pat. No. 2,295, 1889, Reynaud.  
 British pat. No. 17,070, 1889, Moyer.  
 American pat. No. 493,426, 1893, Edison.  
 American pat. No. 495,822, 1893, Meddins.  
 American pat. No. 503,927, 1893, Cox.  
 American pat. No. 514,707, 1894, Emerson.  
 American pat. No. 520,030, 1894, Blackmore.  
 American pat. No. 521,705, 1894, Demeny.  
 American pat. No. 525,991, 1894, Mayer.  
 American pat. No. 528,140, 1894, Blackmore.  
 American pat. No. 536,569, 1895, Jenkins.

**The Use of Perforated Ribbon is Shown.**

American pat. No. 27,572, 1861, Sealey & Lee.  
 British pat. No. 9,807, 1887, Schroyer.  
 American pat. No. 376,247, 1888, Le Prince.  
 British pat. No. 2,295, 1889, Reynaud.  
 American pat. No. 493,426, 1893, Edison.  
 American pat. No. 528,140, 1894, Blackmore.  
 British pat. No. 10,474, 1895, Acres.  
 American pat. No. 536,569, 1895, Jenkins.  
 British pat. No. 12,458, 1895, Blair.  
 American pat. No. 540,545, 1895, Gray.  
 Swiss pat. No. 11,245, 1895, Blair.  
 American pat. No. 544,480, 1895, Demeny.  
 American pat. No. 546,093, 1895, Eames.  
 American pat. No. 547,066, 1895, Farnam.  
 American pat. No. 547,775, Farnam.  
 American pat. No. 549,309, 1895, Cortler.  
 American pat. No. 560,800, 1895, Jenkins.  
*Photographic Times*, May, 1896.



## COMMERCIAL APPLICATIONS.

**A**NIMATED photography, as commercially employed for the entertainment of large audiences, consists of an analytical process by which a photographic record is made of the scene it is desired to preserve, and a synthetical assembling of these separate photographs into a more or less exact counterfeit of the original movement. The favorite method is the making of pictures one above another on a long strip of sensitive film. The synthesis is accomplished by projecting these pictures one after another upon a screen by means of an optical lantern. The projection of the little pictures succeed each other so rapidly that the human eye is unable to separately distinguish them, and the effect is that of a simple picture containing animated subjects.

The entire process is attended with little difficulty and is exactly like ordinary photographic processes, although special mechanism is required to handle the long strips of picture-carrying ribbon. The film is of transparent celluloid, one side of which is coated with a sensitive emulsion, that of the negative being much more rapid than the positive stock, although the latter produces better results for the lantern ribbons. The standard ribbon is  $1\frac{3}{8}$  inches wide and about  $\frac{5}{1000}$  inches thick and in lengths approximately 200 feet to

each roll, the roll when received from the manufacturers being covered with tinfoil and black paper, the whole encased in a box, sealed against the air. Both matt and clear stock surfaces are sold, but there is little demand for matt surface film. These little pictures are not quite so wide as the film, leaving a narrow unoccupied marginal edge, in which are punched the little holes by which the film is kept in register during each step of the entire process. The pictures are  $\frac{3}{4}$  of an inch in height by 1 inch wide, the latter dimension being across the film between the perforations, and are placed one immediately above another, giving sixteen pictures to each foot of film.



## PHOTOGRAPHING.

**T**HE camera is equipped with a photographic lens of large aperture and short focus, so that it will work with quite a quick exposure. I made a number of excellent films under the skylight of my studio in 1896 with a lens about  $f$ -3, possibly  $f$ -4, using a 50% shutter. Single figures limited to a close space were well defined, and it should be remembered that photographs at that time had to be made on the film not less than thirty-five pictures per second, or they would be too slow for use in kinetoscopes. The casing contains suitable mechanism for guiding and feeding the film step by step in the focus of the lens, and a rotary shutter with one or more radial slits therein so arranged that the lens is uncovered only when the film is momentarily arrested, the latter being pulled down quickly between exposures so as to present a fresh surface each time. From fifteen to twenty-five pictures are made per second according to preference or necessity, the exposure depending entirely upon the strength of light and rapidity of movement of the object photographed.

In photographing any scene or subject one of the main things to guard against is the passing of extraneous objects into or across the field of the lens very close to the camera,

thus obliterating the entire view for the time being. Some one ought always to be suitably stationed to see that this does not happen.

The neatest camera I have yet constructed for the narrow film is that shown. The mechanism is of the modified Geneva stop pattern, but is provided with two pins in the driving gear. No tension plate is used, but a channel provided which insures the film against scratching. The casing is a 6-inch cubical box of cherry, having detachable film boxes, which serve exactly the same purpose in this camera that plate holders do in the ordinary camera, that is, a half dozen of these film boxes can be filled in the dark room and taken into the field in a carrying case or other suitable receptacle. Arriving at the desired location the camera is set up, the legs well spread out to give stability, focused, and one of these film boxes secured to the top of the camera, the film led down through the camera and attached to the reel in the receiving box at the back. If the lens is not of universal focus, the best focus is secured by putting in a piece of matt surface film between the tension members to receive the image. After focusing this is removed. The same care should be exercised in focusing, leveling, the use of the finder, etc., as though an ordinary camera were used. Stops in the lens should be selected according to the intensity of the light and size of the opening in the shutter to the speed of the latter, which can be determined accurately only by experiment. Everything being ready, the camera is turned as uniformly as possible until the whole of the film has been wound out of the top box into the receiving box.

The now empty box on top replaces the receiving box, which latter is marked "Exposed" and put into the carrying case. A box of unexposed film is put on top the camera and everything is ready for another exposure. It must be understood that the film which is pulled out of the top box, to be threaded through the camera, is not wasted, for to each end of the unexposed sensitive film is spliced, in the darkroom, a piece of dense black film, say, each five feet long, to protect it from the light and facilitate the threading of the camera. Old, spoiled film will answer, or it can be prepared by developing fresh film in white light. Strips, 75 feet long, so protected with perforated paper strips and wound on flanged spools are now on the market. The film boxes can be left in place on the camera, and the daylight spools just mentioned may be used in them.

A very rapid shutter device for a camera, and one which is at the same time very small, consists of two rotary shutters geared together and to the film feeder so that one shutter rotates faster than the other, and preferably in opposite directions. This construction permits the exposing of the film only when the openings in the two shutters coincide behind the lens and which may be according to any predetermined arrangement. Exposures by this means have no limit for quickness.

The choice of a lens for a camera should be governed by the focal length, together with the rapidity and depth of focus, it being understood, of course, that the lens is free from astigmatism and from chromatic and spherical aberration. The shorter the back focus the greater the depth of

focus; and the larger the proportion of the aperture to the equivalent focus the greater the rapidity.

Most photographic lenses are marked in “*f*” numbers, on what is known as the “U. S.” system, that is, the aperture is expressed as a fraction of the equivalent focus. Now with a given lens a stop with an aperture of twice another has an opening four times the area, admitting four times the light, so that the exposure for the latter would be four times that through the former to get the same exposure. The converse is also true, that a negative twice as far from a given aperture requires four times the exposure, because the light on the plate or film in the second position is spread over four times the surface in the first position. A lens of four-inch equivalent focus and with diaphragm stops having openings of  $\frac{1}{2}$ ,  $\frac{1}{4}$ ,  $\frac{1}{8}$  and  $\frac{1}{16}$  inch would have the stops marked *f*-8, *f*-16, *f*-32, *f*-64, respectively, each being that fraction of the equivalent focus of the four-inch lens to which they belong. However, makers usually mark stops between these so that each requires but twice the exposure of the one next larger. It will thus be seen that a ready means of judging of the working speed of different lenses is available, for a comparison of the “*f*” numbers gives the desired information. Some makers, however, have adopted a system of numbering which gives only the comparative exposures for the stops of that particular lens, each requiring twice the exposure for the next larger, thus,  $\frac{1}{4}$ ,  $\frac{1}{8}$ ,  $\frac{1}{16}$ ,  $\frac{1}{32}$ , etc.

In order to more surely get a proper exposure at all times, it is well to remember that: a seascape requires the quickest exposure; that an open landscape requires about three

times as long; that foreground, nearby objects, buildings, etc., about six times; portraits inside under good light about one hundred times; that the light in June is about four times as effective as it is in December; that the light from 10 A. M. to 2 P. M. is more than twice as actinic as it is from 4 to 6 o'clock; that the speed of the shutter must be quickened inversely as the distance to the object photographed, the latter having a given movement; and that a large lens is not more rapid than a small one if the proportion of diaphragm to focus remains unchanged.

Photographs made with chronophotographic cameras quite often contain a wealth of valuable information for studies for the artist and scientific worker which is easily so accurate as to meet the most exacting requirements—may be, photographs of that which happened when the photographs were made, one, twenty, a hundred years previously, and which may have been sent from a distance of many miles in a package no larger than a bundle of lead pencils. On examining the pictures of a horse jumping a hurdle it is found that he lands on all four feet or nearly so, so that one might almost encircle them with one's arms. A photograph of the wing of a flying pigeon resembles a propeller blade, the cutting angle of which increases as we move outward along the wing. A cat dropped from a height of, say, but forty inches will turn over and land on his feet. His feet are drawn up in a peculiar manner against his body and the turn is made while falling through a distance of about two and a half feet. So far as I have yet been able to observe he always turns over in the same direction. I do not know that this would hold,

invariably, with all members of the feline family,—possibly not.

An explanation of the detail of making ray filters and tinters for experiments in the newer advances in animated picture projecting methods might not be inadvisable here. The regular gelatine coating of glass plates, afterward to be soaked in the color desired, is, of course, a satisfactory method, but the utilization of old plates is not only economical, but quite a satisfactory practice. Unexposed developed and fixed plates of suitable size, or a fogged plate cleared in a reducer, are thoroughly washed, and soaked in the colors. This is quite satisfactory, cheap, and easily performed. Large plates can, after drying, be cut into suitable sizes. Chromatic colors will be found in the formulas.

Some interesting results have been achieved in moving pictures using tele-photo lenses. The method is not recommended except where it is absolutely impossible to obtain the same result in the ordinary manner.

It might not be amiss to mention a combination, for distant objects, applicable, however, mainly to ordinary photographs, using two or more cameras, bringing within easy reach objects which are otherwise inaccessible. The result is thus obtained: A camera is set up as though to photograph the view containing the object of which the larger picture is desired. After properly focusing on the distant object, a second camera is set up and focused on the ground glass of the first instrument. When this is done, the ground glass of the first camera is removed and the focus carefully examined a second time. Fill up the gap between the instruments by



wrapping around with the focusing cloth. Put in a plate and expose. On developing the plate a beautifully sharp image of the object is found as large as though photographed from a nearby position. Two or three or more lens combinations may thus be used, making the enlargement anything desired without grain in the resultant picture, results far in excess of

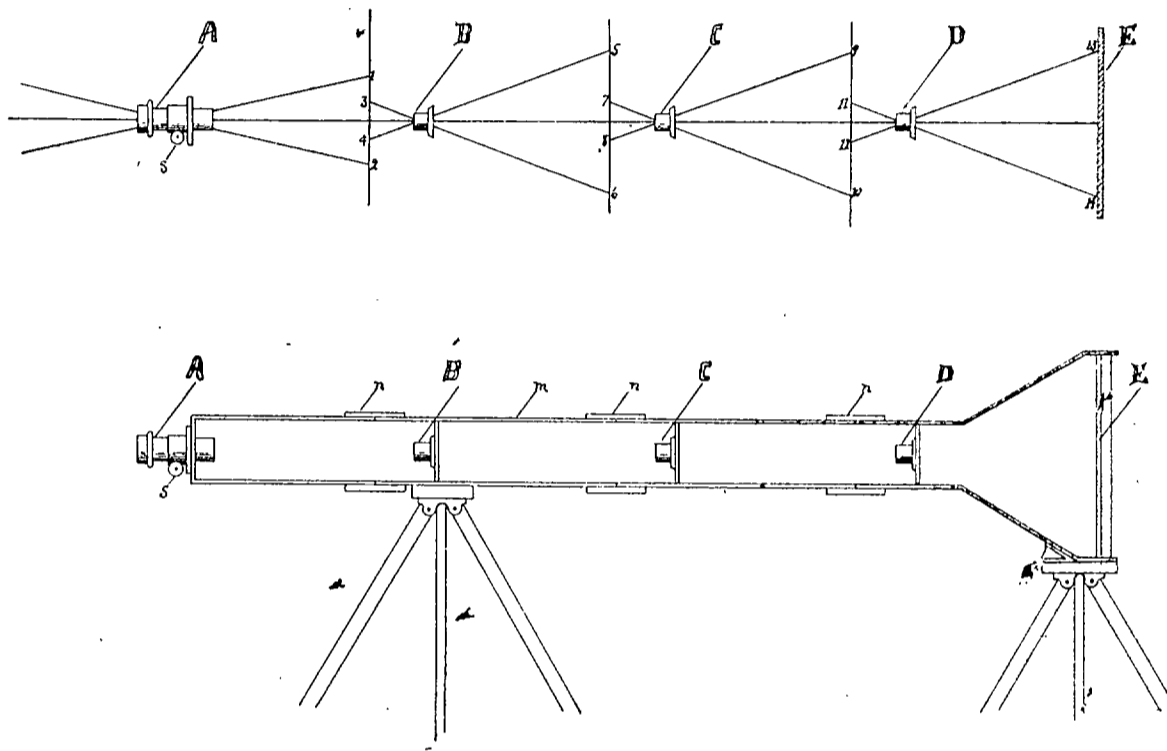

any tele-photo combination ever constructed. The cut shows a combination of lenses giving an enlargement of first image of 625 times with a telephoto lens and three enlarging lenses.

A cabinet photo of the statue on the dome of the National Capitol was thus made from the U. S. Treasury building, using common lenses.



## DEVELOPMENT.

**H**AVING succeeded in properly exposing the long ribbon in the camera, the next step in the process, development, is to be undertaken. To develop this strip, say, 100 feet long, carrying on its gelatine surface some 1,600 latent images, is worthy the effort of the most patient photographer, for each

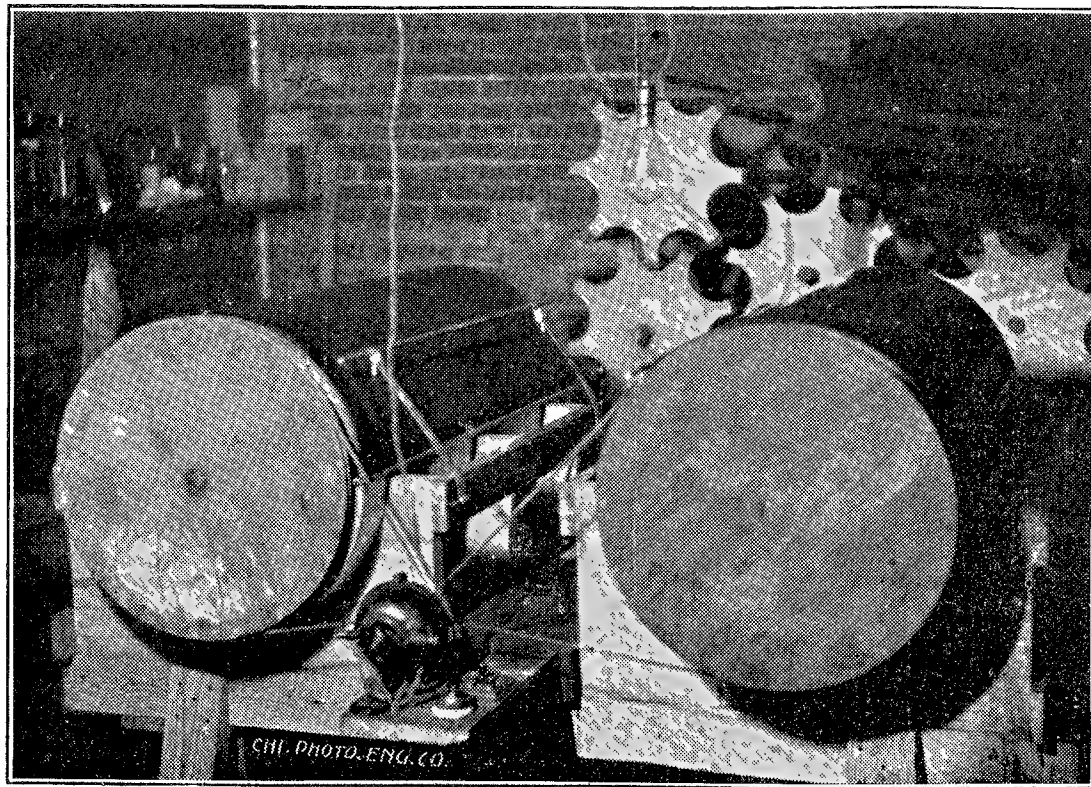

picture must have the same density, remain without stain throughout, and must be handled so as not to be abraded in any part of its length. It is almost needless to say that the film can not be cut into short pieces to be developed separately, even were this a desirable consummation; and the

horror of tackling such a length of delicate material loose in a bucket of developer would make the most daring quail. The method most in use consists in winding the film spirally while dry upon a large drum, the latter supported free to rotate in a semi-cylindrical tray into which the developing fluid is poured. These drums are usually three feet or more in diameter and six feet or more in length. Another form is that known as the pin-tray. An X-frame is studded with vertical pins upon which the film is wound in concentric spirals, the convolutions being thus held separate. When so arranged the film is placed in a suitable tray and treated like a large plate. As the film stands on edge a consid-

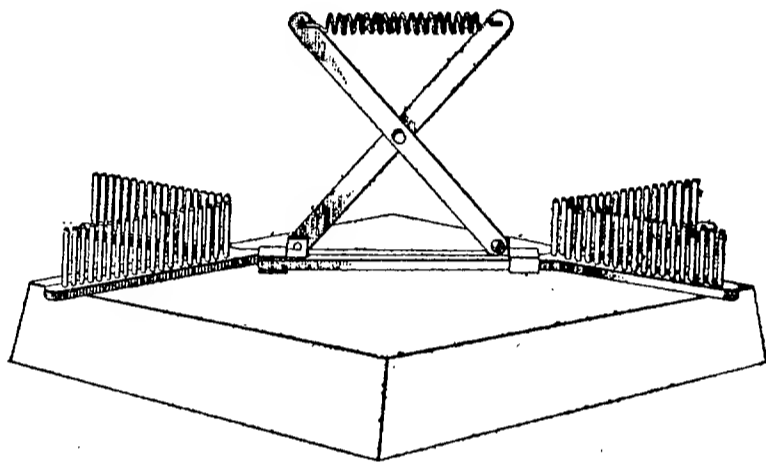

erable depth of developing fluid is required to cover it. However, if several films are ready for development one after another this does not count for much, for the same solution can be used for several of them before replenishing.

When I first began to develop these long lengths of film I used a pair of spools supported over a tray in which the developing fluid was held. It is the neatest possible form of developer, one which is very small, simpler than any other, and which requires a modicum of developing solution. It consists of a frame supporting two flanged spools above a long narrow tray. One end of the film is attached to one of the spools, upon which it is wound, and then passed, gelatine side down, through the fluid, being held therein by

small rollers at each end of the tray and the other end of the film fastened to the other spool. The film after saturation is wound from one spool to the other through the solution again and again until full detail and proper density is secured, which can be determined by picking up the slack of the film and examining it before a conveniently located non-actinic light. The trays are readily removed, without disturbing the spools holding the film, and the washing, fixing, hardening, soaking, etc., can therefore be quickly and conveniently done. I have used every known form of apparatus for developing these long strips of film, and none of them equal this for convenience, simplicity, economy and excellence of product, and I have had it in use longer than all other forms combined.

The temperature of the dark-room should be maintained at about 75° Fahrenheit, and the developer, when poured into the tray, should not be too cold in winter or too warm in summer. Good results can not be expected otherwise.

After thoroughly washing, the film is carefully reeled upon a drying rack and hung up, in a draft of air preferably, to dry. In all the operations care should be exercised to see that the gelatine is not skinned or knocked off.

Two chemical compounds enter into the matter of development, the developer (pyro, for instance) and the accelerator (an alkali). For a normal exposure a certain given amount of each diluted with a certain amount of water produces the best result. An excess of developer will give hard contrasts, although advantageous to use for an overexposure; while an excess of alkali gives more softness and detail in the shadows

and is therefore advantageous for an underexposure. Giving the film a preliminary bath in an alkali before development is worth resorting to for an underexposure, while the use of old solution retards development and is recommended for overexposures. An excess of water also checks development and consequently insures more strength in underexposure. For a normal exposure more water gives softness and less water contrast.

In endeavoring to judge of the cause of bad negatives it is well to remember that a weak negative with clear shadows indicates underdevelopment, while strong highlights with clear shadows means underexposure. Density with plenty of detail in the shadows means overexposure, and "flatness" overexposure and underdevelopment.

Daylight for a dark-room illuminant is not recommended, artificial light being more uniform. The writer uses green and orange glass and finds the combination soft and pleasant to the eyes and excellent for examining film. In order to be assured that one's light is safe, it is well to test it. Expose half of a short piece of film before the dark-room light for, say, one minute, keeping the other half protected. If development leaves half of the film clear and the other half cloudy the light is not safe. A sheet or two of post-office paper, a reddish yellow paper, will probably correct it.



## PRINTING.

**T**HE printing of the positive or transparency is the next step. The negatives, until wanted, are kept rolled up and stored in a case fitted with shallow drawers. The printer is generally so constructed that the negative and sensitive unexposed positive are drawn along past a narrow opening

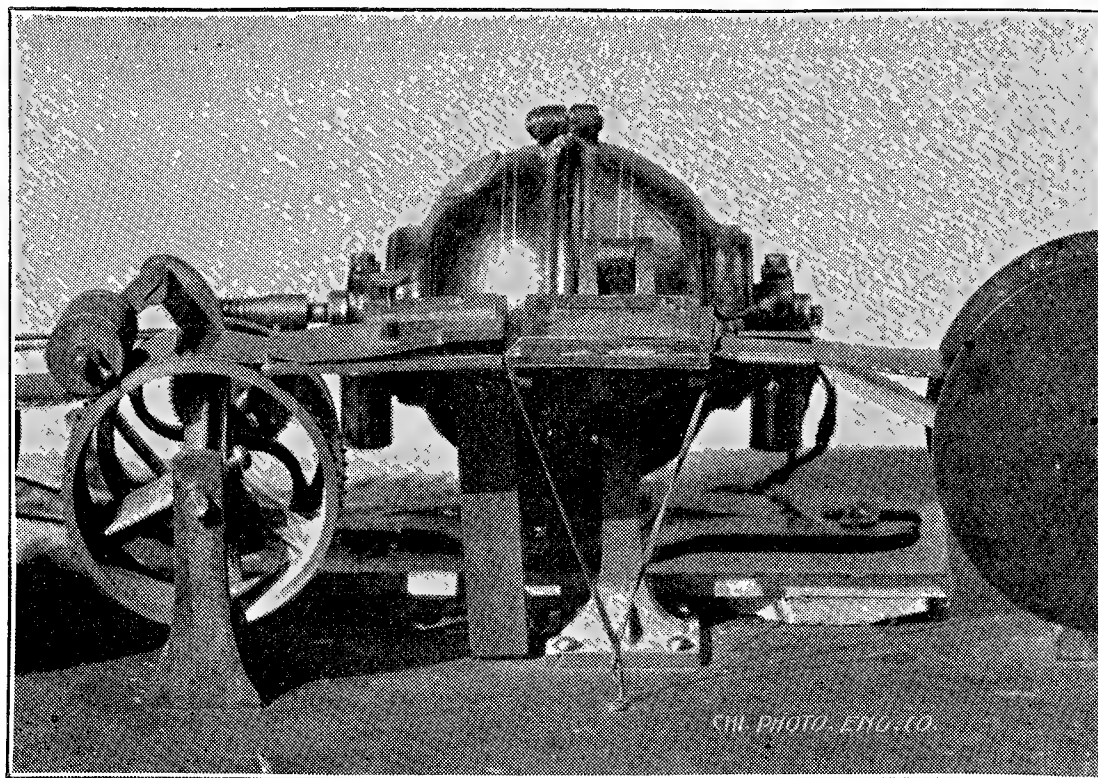

AN OLD PRINTER.

beneath the light, exact registration being secured by having the teeth of the feeding sprocket project through both, although some operators employ a machine having two sprockets, one to feed the negative and the other to feed the unexposed film, arguing that because the negative, which shrank a little in

drying, after development, is shorter than the fresh film, the latter drags slightly behind the negative. This is an erroneous theory, however, for if it were actually true, the positive would soon fall so far behind that it would not go on the teeth. The printer adopted by the writer (and he has tried several methods) as giving the best results, consists of a narrow box in the center of which a sprocket is located free to rotate by means of a worm and gear, on the outside, which latter can be driven by hand or by mechanical motive power. There is a narrow opening in the lid of the box so located that when the lid is closed the opening therein comes immediately over the center of the sprocket. In use the negative and the unexposed sensitive film are dropped into the end of the box, and both held down upon the sprocket teeth, the negative of course on top, gelatine surfaces in contact. The lid is shut down, the box placed beneath a suitable light and the sprocket rotated. This is the most simple form, has many advantages and gives unsurpassed results. The novelty of the device is that the films move continuously under a uniform source of light without intermittent motion or the use of shutters. The two films are drawn beneath the light together, the exposure is regulated by increasing or decreasing the opening in the lid of the box or by placing the printer such a distance from the light as best suits the density of the particular negative used. The temperature of the printing room should be maintained at about 75° Fahrenheit.

A trouble which causes more annoyance than any other is imperfect registration of the pictures in the camera from faulty construction. It will readily be understood that if the

camera does not advance the film to exactly the same position before each exposure—and it is readily discovered by observing that the little lines of separation between the pictures are not all alike (sometimes white, sometimes black)—no printing or other after process can correct the error so as to secure steady pictures when projected upon the screen, be the manipulation ever so concise. But, given a perfect negative, the battle is more than half won, for if the perforations are at all near correct good positives ought to be secured. Even imperfect perforating will not be noticed if the feeding sprocket is situated near the point of exposure in all forms of the apparatus. Uniform results depend more upon this point than upon any other detail.

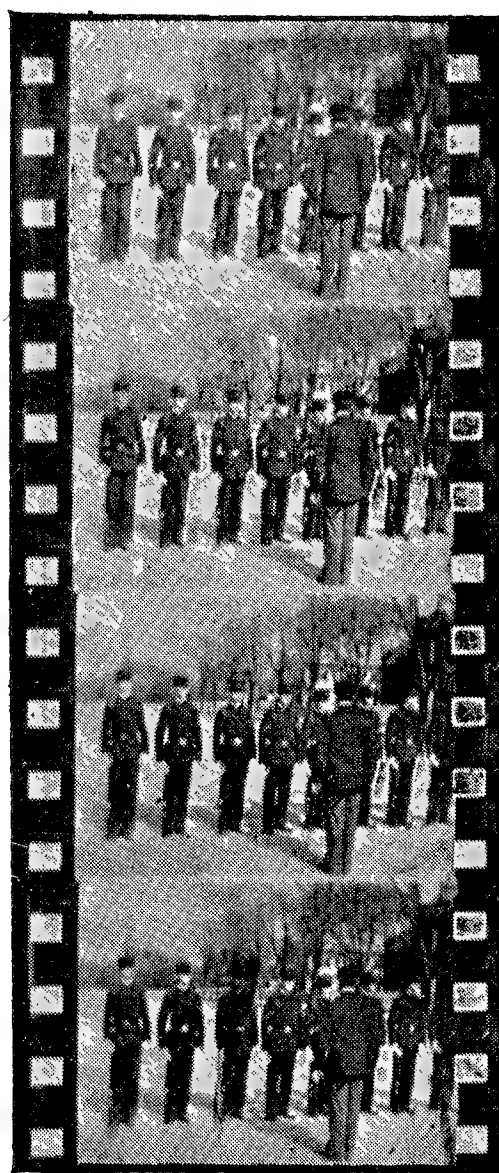

In developing the positives care should be exercised to see that the whites are perfectly transparent, in fact, treat the film as though one were making a lantern slide.

After the film is thoroughly dry it is unreeled and the ends spliced together so as to make an endless band and then reeled upon two small, short spools or rolls of paper, one on the inside and the other on the outside of the loop. A small spool is also inserted in the loop after it is wound up. These spools are inserted to prevent creasing the film when a rubber



band is snapped around the roll to hold it from unwinding. Where desired, boxes having these spools already fixed therein, may be provided for the shipment of the film or the film may be rolled up without splicing, which is the better plan.

In splicing, an end of the film is cut square across, and, with a straightedge held tightly down upon it so as to expose one pair of holes beyond the straightedge, the gelatine is dampened with the finger and when almost surface-dry is gently rubbed so as to leave the end of the film bare for about one-eighth of an inch. If the gelatine is properly dampened it will be found to roll up under the thumb so as to leave the celluloid perfectly clean. The other end of the film is then cut square across and so that when placed upon the bared end, the pictures correctly register. With the ends of the film held firmly in place, a corner of the splice is raised with the point of a knife and collodion applied by a touch only. The collodion should be applied as quickly as possible before the ether has had time to volatilize, and the film ends instantly pressed together and so held for four or five seconds. Then raise the other corner of the splice and make a second application of collodion. A little practice and dexterity will result in good, smooth splices. Common commercial collodion with 20 to 25 per cent. of extra ether added can not be excelled for splicing collodion strips. The application should be made with a small stick mounted in the cork, and not with a brush. Thick collodion will not make good splices; it should be thinned with fresh ether occasionally. When acetone or amyl acetate is used as a splicing solution a "film-mender" is almost a necessity.

## PERFORATING.

**T**HE perforator built by the writer for punching the marginal rows of little holes in the film stock by which the ribbon is fed, and which insures automatic registration of the pictures, opposes generally accepted mechanical methods in its construction. It has a vibrating table hinged at one

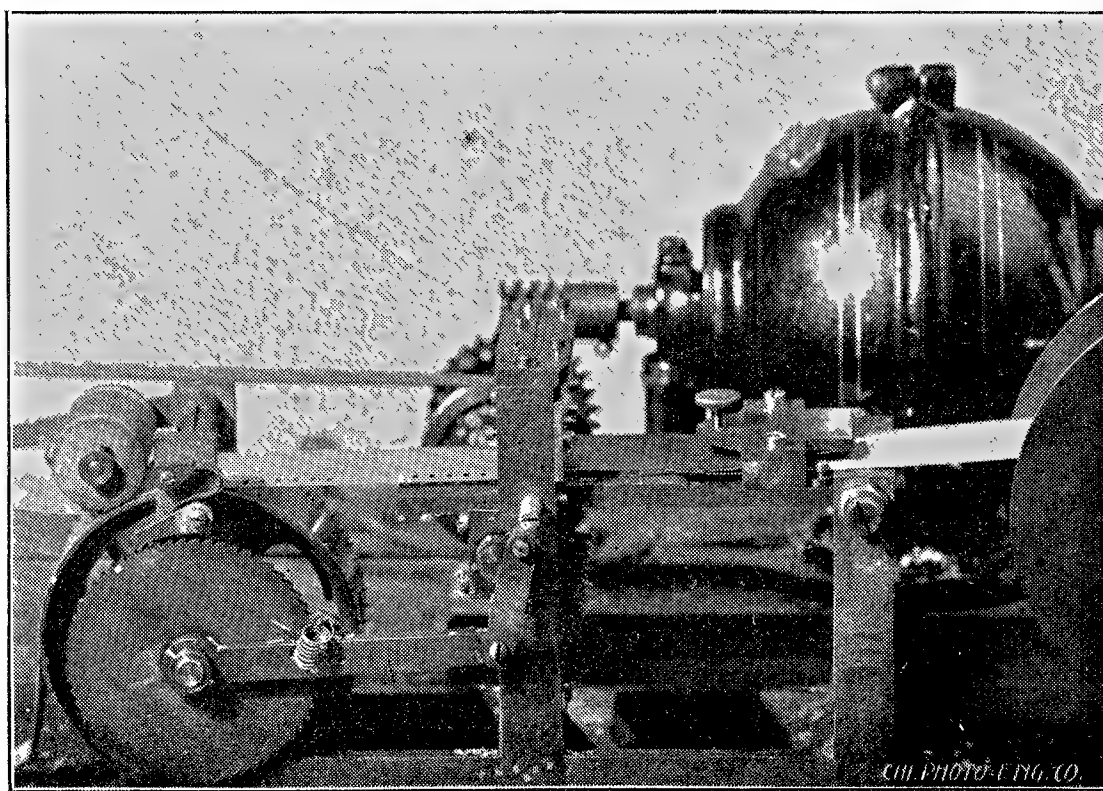

JENKINS' PERFORATOR.

end on pin bearings, the other end carrying the tempered steel punch plate. The table is raised about one-sixteenth of an inch by a cam pinching the film between the die-plate and the punch-teeth, which latter are firmly screwed to the frame. Thus it will be seen that the table moves in an arc,

which would seem to cause wear on the teeth, but such is not the case, for the arc is too short to give any trouble. Micrometer adjustment of the spacing between the perforations is provided for by slightly moving the spacing sprocket (by means of knurled head not shown), though why moving the spacing teeth farther or nearer the punch teeth should make the holes closer or farther apart, respectively, is a fact still open to satisfactory explanation. A uniform speed motor is employed and about 15,000 perforations per hour the working rate. This is as fast as is recommended, owing, among other things, to the liability of the film to generate static electrical charges. The film seems quite susceptible to this trouble, as can readily be seen by any one who will tear a piece of the film in the dark with a sharp jerk, which action will make a light blue flame shoot out, ruinous to perfect film.

When the punch teeth become dull from accident or long continued use, any expert mechanic can sharpen them, as follows: Remove the plate having the teeth thereon, rest it firmly on a small anvil or other suitable support and gently upset the points with a light smooth-faced hammer. After being sufficiently upset to prevent the teeth going into the holes without touching on any side they are finished on the ends with a smooth file very carefully held flat. Now replace the punch plate, touch each tooth with a drop of oil and carefully and slowly force the teeth into the lower punch plate, which will shear off the edges of the teeth and the punch is ready for use. This when properly and carefully done will then punch holes smooth and clean. If possible, the frame should never be disturbed, once it is set up. A

jeweler's glass will be of assistance in determining the condition of the punch-teeth at any time and also the character of the punched holes.

The writer constructed the perforators for the two largest manufacturers of film, and can guarantee the correctness of the perforations. It is not, therefore, necessary for every one to go to the expense of building a perforator in order to take up work of this kind, and besides the design and construction of a perfect machine is no mean problem, and many thousand feet of film would have to be used before the slight additional cost for perforated film, known to be correct, would equal the cost of a perforator,—and then one does not have to bear the expense of the film spoiled in the punching.

Of the holes which have been spoken of as being punched along each edge of the film in order to automatically register the pictures, there are three general shapes—that is, a round hole, a round cornered rectangular hole, and a square-cornered hole. A round hole is most generally used in the machines with sprockets, as sprockets to fit such a film would have to be drilled for each tooth, each being driven into the drilled holes after having been smoothly pointed. The round-cornered hole was doubtless adopted by its advocates under the impression quite generally entertained by mechanical engineers that a square-cornered perforator tooth can not economically be kept sharp. This has been proved entirely erroneous, at least so far as the perforating of film goes. The punch teeth of the perforators built for the manufacturers of film after perforating thousands of feet of film stock

(and there are 128 perforations to each foot of film) were in as good condition as when first set up. This supposed difficulty would not, however, be sufficient to condemn the square-cornered hole even though it should thereby upset mechanical traditions. The sprockets are cut by turning down in a lathe the face of the brass cylinders so as to leave two little conical ridges the proper distance apart upon its circumference. The cylinder is now put into a gear-cutting machine where the ridges are cut away in part so as to leave tits or teeth, the shape or pitch being determined by the diameter of the sprocket. This process produces teeth of rectangular base cross section. Now the tooth, in intermittently feeding the film forward in the lantern as it does, by little jerks, takes the strain, not upon its advancing face, as it should, but upon the corners, as shown, eight times magnified. The error of such a method, that is, when a round-cornered hole is used with a square-tooth sprocket, soon begins to manifest itself by little irregular white lines in the forward or attacked corners. Upon examination, these little irregular lines are found to be minute ruptures which continue

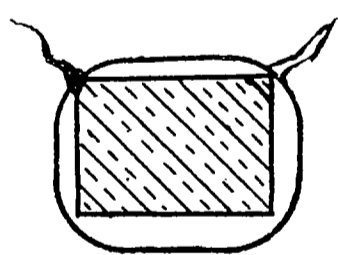

to grow in length until finally the holes are torn entirely to the edge of the film, and while the picture surface is still in good condition the film must be thrown away because it will not go through the projecting machine without parting too frequently. If the corners of the sprocket teeth are rounded so as to more nearly coincide with the shape of the holes it must be done entirely by hand, and that, too, corner by corner of each tooth, for a burring tool will give a cir-

cular arc of  $90^\circ$  only on a square tooth, and the film would fit little better than before. Neither could it be made to continue to fit the face of the corrected tooth, for the film is constantly changing with the changes in the temperature and humidity of the atmosphere. This expensive process would not, therefore, be of any lasting benefit, while if the trouble were eliminated at the start by perforating true rectangular holes, holes which would keep their shape and approximate the natural base cross section of the tooth the object sought would be accomplished in the easiest and most natural way. Neither would the changes of temperature or humidity affect the feed or fit. A glance at the figure shows the reason for this. It is apparent that the face of the tooth comes squarely against the edge of the hole, which receives the entire strain. Films so perforated do, in actual practice, as one would naturally suppose, outlast the film having perforations of the other shape. And it is to be hoped that the rectangular hole will be generally adopted by the manufacturers of film stock and picture ribbons requiring perforations, which will introduce a saving to the poor exhibitor, whose trials and vexations are legion already.

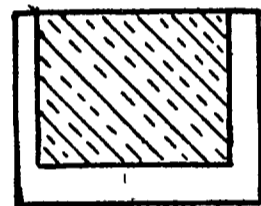

## COATING FILM.

**T**HE coating of the film by the manufacturers of film stock is an interesting process, although concealed from the public generally. However, to reveal the method avails but little, as the most of success depends upon the formulæ and the minutiae of the process. The film is slowly drawn, in the coating machine, beneath a hopper with a narrow lateral slit in such a way that the full width of this great web, 22 inches wide and anywhere from four to six hundred feet long, is evenly coated. As it is drawn from under the mouth of the emulsion hopper it is carried along gradually with an ever decreasing movement until it hangs in great folds from a little trolley track near the ceiling of the drying room. Another method consists in carrying the emulsion hopper along over the surface of a stone or glass top table upon which the celluloid has been spread and dried. After coating, the film is rolled up and passed through a machine which splits it into the proper width, the length, in the meantime, being measured by a little instrument which accurately records the number of feet passed.

## PROJECTION.

**T**HE accepted plan for conducting an entertainment of animated pictures is to have each picture announced orally or by a special slide in an auxiliary lantern before the picture is thrown upon the screen. This enhances its acceptability and the interest of the audience in the picture, especially so if attention is called to some prominent feature in each. Appropriate music is usually rendered during the exhibition of the picture, which is not only entertaining, but pleasantly diverts the attention of the audience from the noise the projecting machines make. During the intervals between the pictures the auditorium should be but dimly lighted. This will prevent the pupils of the eyes of the audience contracting, which would cause the pictures when first projected upon the screen to be less readily distinguishable. If the films are spliced together so that proper registration is maintained throughout and all wound on one large reel, the intermission between the pictures need not be so long as would be the case if each film had to be put into the machine separately. Splicing blank pieces between picture ribbons enables the operator to stop the feeding mechanism before running into the following picture.

As a signaling apparatus between lanternist and speaker,



the most satisfactory device known to the writer is the electric signaling apparatus customarily employed, with the exception that a tiny electric lamp is substituted for the "buzzer." This makes no noise whatever, is entirely efficient and can be mounted anywhere—stuck into the operator's coat if desired.

The projection of these picture strips is accomplished in a lantern fitted with a special attachment for feeding the pellicular band through the light, which is usually that of an electric arc lamp, as no other form of illuminant is sufficiently intense to give well-lighted pictures on a large canvas; for it will be remembered that the picture is scarcely one-fourth as large as an ordinary lantern slide and therefore only about one-sixteenth the area; in other words, to secure the same brilliancy on the canvas it is necessary to use a light many times more intense than for an ordinary slide. This condition is bettered somewhat by putting the ribbon farther from the condenser. This is done in order that the picture shall intercept the cone of light at a point where the greatest square inside the colored rays can be had. However, the film must remain in the focus of the objective lens, which, therefore, must be slipped forward, necessitating a lengthening of the whole optical system. Moving the celluloid film nearer the focus of the condensers necessitates the insertion of a water cell to intercept the calorific rays, else would the film, which is very inflammable, catch fire when stopped, if for only a few seconds. A saturated solution of alum is placed between the condensers and the film and effectually protects the latter. Alum solution is somewhat more opaque

to heat rays than clear water alone, although the latter is quite sufficient for all ordinary purposes, especially if the cell is two or two and one-half inches thick. The water is procurable at a moment's notice, and is so transparent to light rays that it is impossible to say, on looking at the screen, when and when it is not employed. However, even should

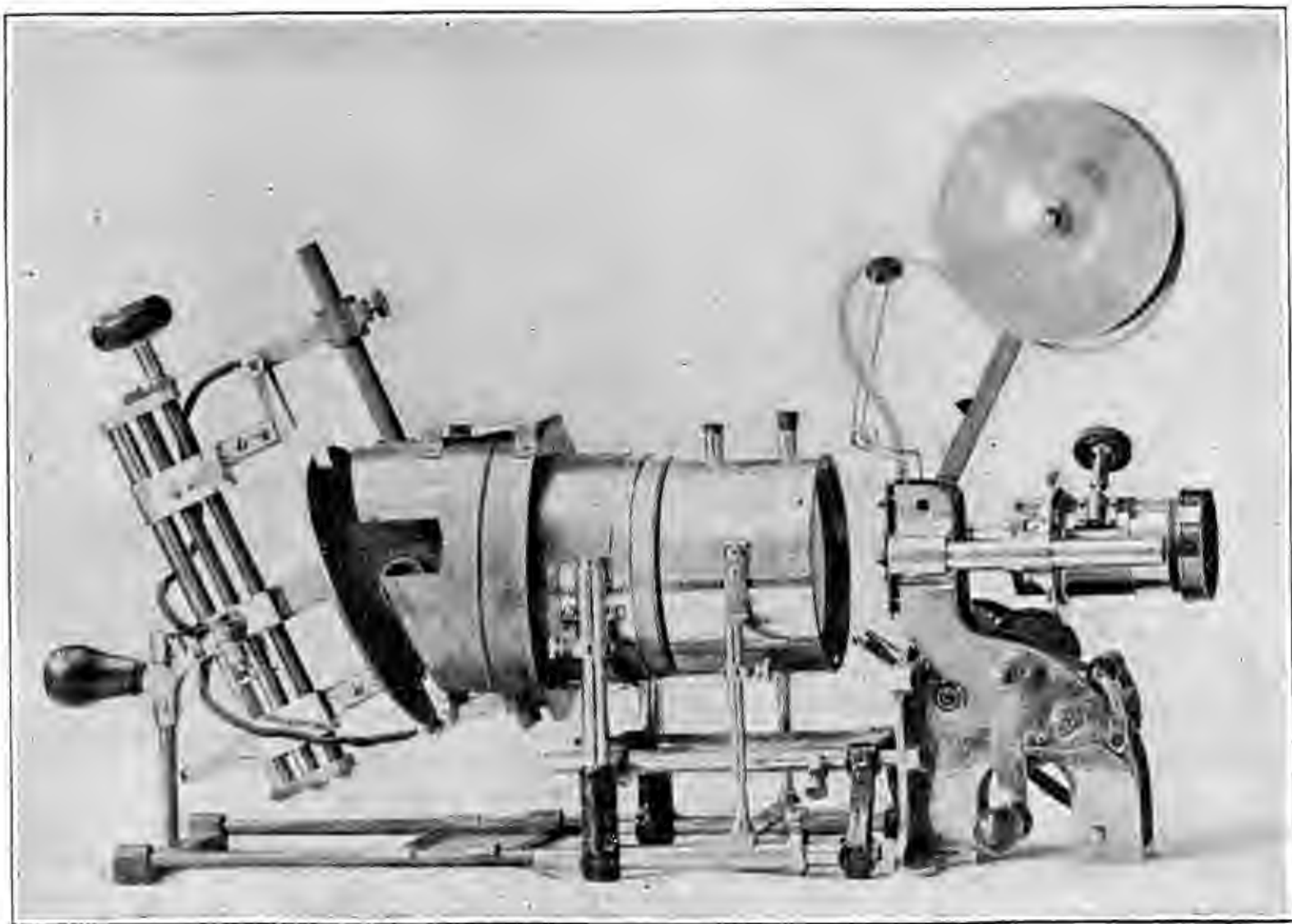

the film become ignited it is not likely to cause any further damage than the burning of a square hole at the point of exposure. The tightly-rolled ribbons do not readily catch fire, although winding them from a metal magazine, past the point of exposure and into a metal receiver still further insures safety. Leaving them hanging loosely about the room

is to be condemned in the most severe terms. Such negligence was the cause of great loss of life and property at the Charity Bazaar in Paris in 1897.

The registering of the pictures should not be done on the screen. If the little door which is used between the condenser and the film is not too closely fitted enough light escapes around it to illuminate the picture sufficiently to register it. The focus ought to be secured before the commencement of the entertainment, and does not need to be changed until either the machine or the canvas is moved.

Moving picture lanterns obey the same laws governing other projecting stereopticons. That is, the illumination of a screen falls off as the square of the distance to the screen; the loss of light by moving the lamp back from the condensers is as the square of the distance that the lamp is moved; the picture rays and the light rays should coincide; the light rays should cross in the objective; and putting a plano-concave lens between the picture and the objective lengthens the focus of the objective and reduces the size of the picture on the screen. The projecting machines are placed in balconies well back in order to get satisfactory enlargement of these small pictures on the canvas.

For a screen any white opaque material is suitable, and much more satisfactory than a transparent one. Nothing is better than a white kalsomined surface. Do not wet the screen.

The following table gives the various sizes of pictures to be had with different objectives, using a standard picture  $\frac{3}{4}$  inch high:

| SIZE OF LENS.            | DISTANCE IN FEET FROM OBJECTIVE TO SCREEN. |       |       |       |       |       |       |       |       |       |
|--------------------------|--|-------|-------|-------|-------|-------|-------|-------|-------|-------|
|                          | 20   | 40    | 60    | 80    | 100   | 120   | 140   | 160   | 180   | 200   |
| Special wide angle . . . | 6½   | 10    | 13½   | ..... | ..... | ..... | ..... | ..... | ..... | ..... |
| Wide angle . . . . .     | 3½   | 6⅔    | 10    | 13⅓   | ..... | ..... | ..... | ..... | ..... | ..... |
| ¼ size . . . . .         | .....                                      | 5     | 7½    | 10    | 12½   | 15    | ..... | ..... | ..... | ..... |
| ⅓ size . . . . .         | .....                                      | ..... | 6     | 8     | 10    | 12    | 14    | 16    | ..... | ..... |
| ½ size . . . . .         | .....                                      | ..... | ..... | 6     | 7½    | 9     | 10½   | 12    | 13½   | 15    |

The following table gives the various sizes of pictures to be had with different objectives, using a picture two inches in height:

| SIZE OF LENS.      | DISTANCE IN FEET FROM OBJECTIVE TO SCREEN. |       |       |       |       |       |       |       |       |       |       |
|--------------------|--|-------|-------|-------|-------|-------|-------|-------|-------|-------|-------|
|                    | 10   | 20    | 30    | 40    | 50    | 60    | 70    | 80    | 90    | 100   | 110   |
| Wide angle . . .   | 4⅓   | 8⅔    | 13    | ..... | ..... | ..... | ..... | ..... | ..... | ..... | ..... |
| ¼ size . . . . .   | .....                                      | 6⅔    | 10    | 13⅓   | ..... | ..... | ..... | ..... | ..... | ..... | ..... |
| ⅓ size . . . . .   | .....                                      | ..... | 8     | 11⅔   | 13⅓   | ..... | ..... | ..... | ..... | ..... | ..... |
| ½ size . . . . .   | .....                                      | ..... | ..... | 8     | 10    | 12    | 14    | ..... | ..... | ..... | ..... |
| ⅔ size . . . . .   | .....                                      | ..... | ..... | ..... | 8⅓    | 10    | 11⅔   | 13⅓   | 14⅔   | ..... | ..... |
| 4-4 size . . . . . | .....                                      | ..... | ..... | ..... | ..... | 8     | 9⅓    | 10⅔   | 12    | 13⅓   | 14⅔   |

From the above table the size of canvas covered by any slide may readily be calculated by multiplying the dimensions given by the proportionate size of the two slides.

Now with reference to the advantages and disadvantages of a wide film. Of the disadvantages it would seem hardly necessary to speak, for there is but one of any consequence, namely, that of increased outlay for stock. It is, however, very much over-balanced by the advantages to be derived

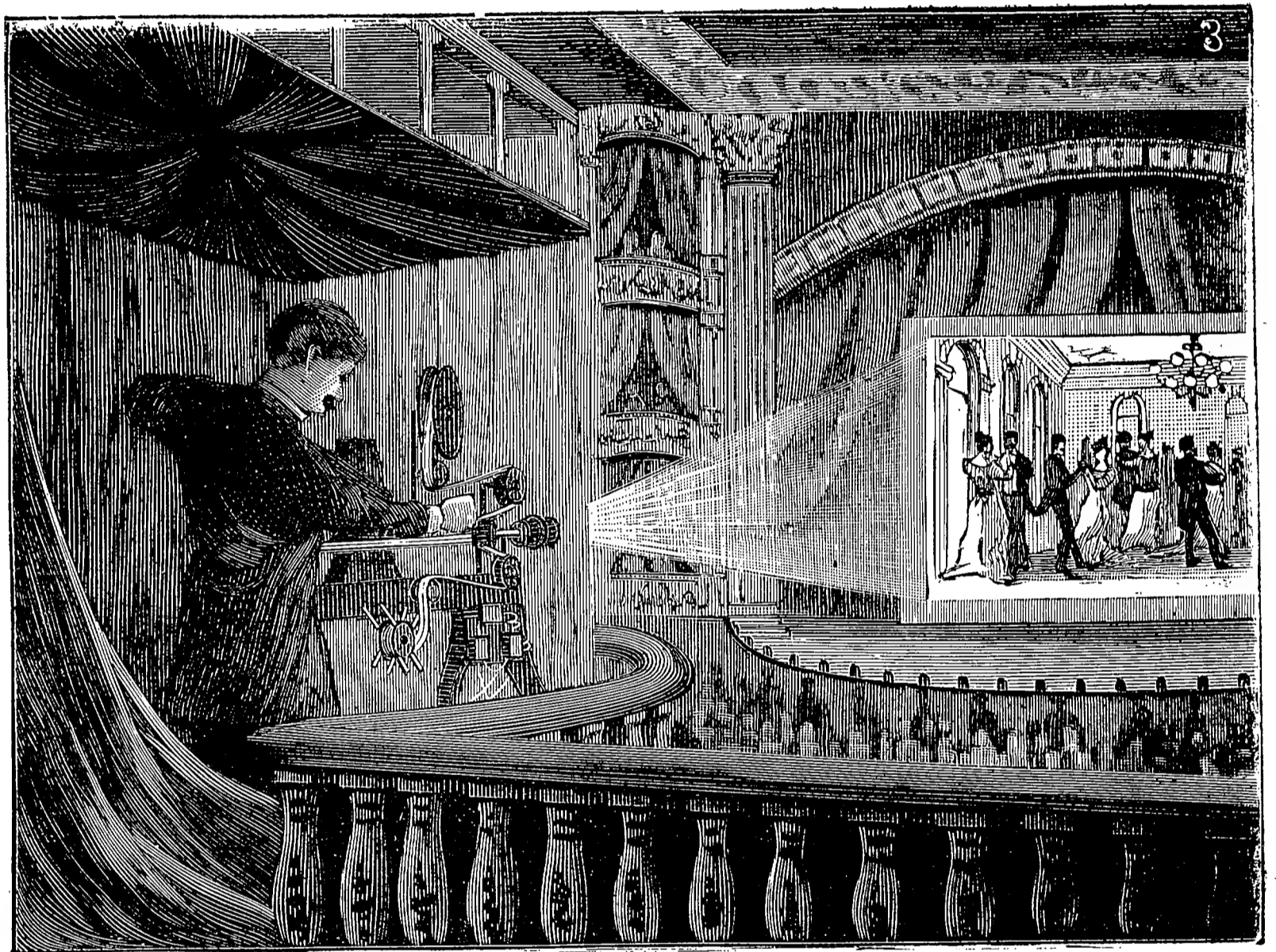

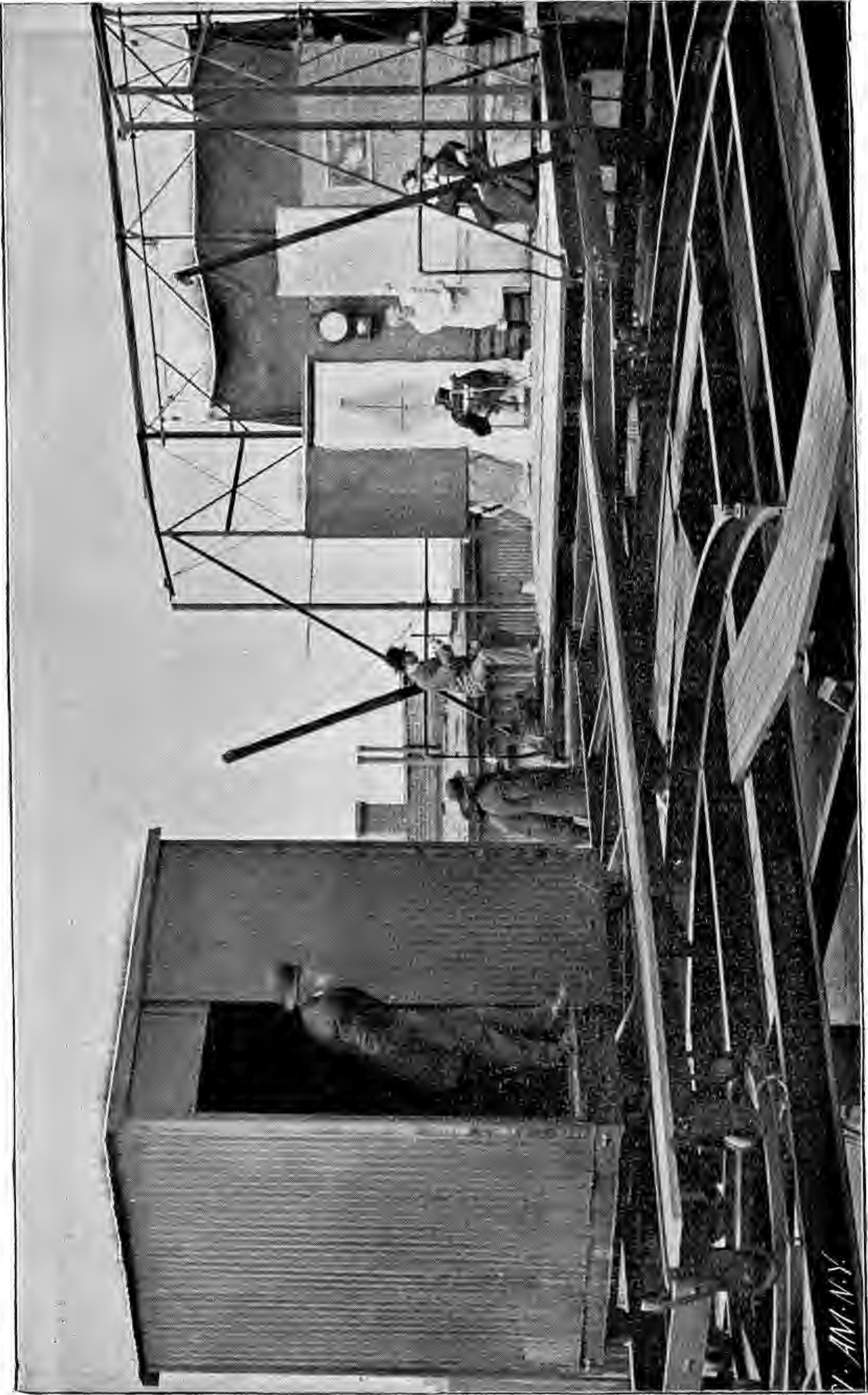

V. AM. N.Y.

from the use of the greater width. For instance, the  $2\frac{3}{4}$ -inch film carries a picture 2 inches in height, that is, each individual picture of the series is 2 by  $2\frac{1}{2}$  inches. It is apparent, therefore, that the area of the picture is more than four times as great as the area of the narrow film. This means that a screen of any given size will be more than four times as brightly illuminated as when the narrow film is employed. The converse is also true that with the same size screen the same illumination of the canvas can be secured with a lamp of less than one-fourth the candle power. This is known to all experienced lanternists. But there is another advantage which is not generally recognized, that is, that canvas pictures of the same size projected from wide film are very much less shaky than those projected from narrow film, other things being equal. This is obvious when one remembers that the projected light acts precisely like a lever with the short end at the lantern and the fulcrum in the optical center of the objective. If, therefore, the lever is but half as long in the first instance the movement of the end on the screen will be but half as great. Shakiness on the screen, it will be remembered, is caused by the failure of the mechanism to pull all the pictures on the film to exactly the same position in the lantern. Therefore if the screen is further from the machine in one case, other conditions remaining alike, the shakiness will be more noticeable, and vice versa.

A hand-feed arc lamp is the most common source of illumination, although oxy-hydrogen or calcium light is frequently employed and is entirely satisfactory with wide film,

and even acetylene gas under pressure may be used with a small screen.

The cost of using the electric arc is at present about one-sixth that of calcium.

Electric lamps require a pressure of near 45 volts. Surplus voltage is taken up in a rheostat (in series with the lamp), preferably a variable one, with an attendant generation of heat in the rheostat.

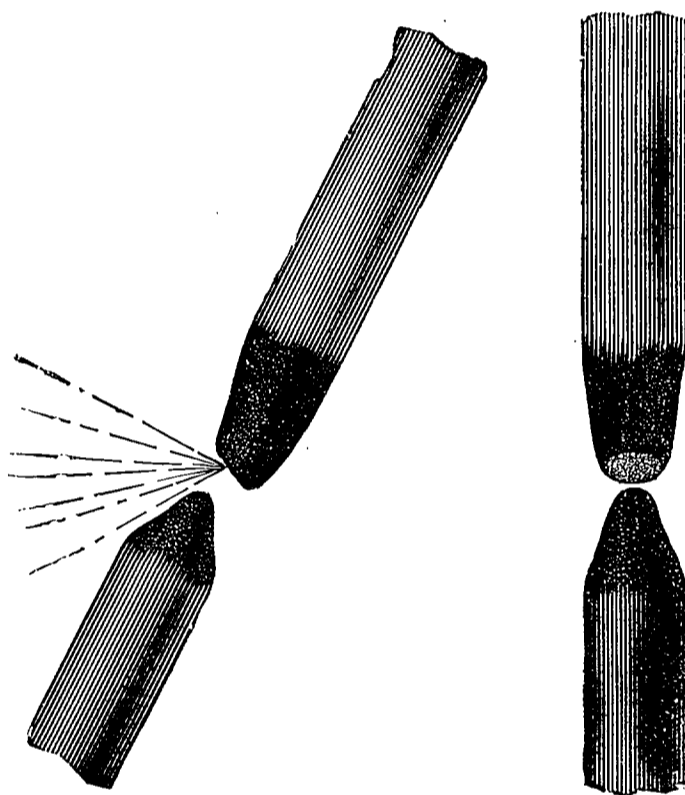

To successfully illuminate a large screen a heavy current is necessary and a great deal of heat is generated in the lamp, which endangers the film owing to its inflammable nature, and for this reason an alum tank should be provided, as already explained. Plain clear water is quite efficacious for short runs, after which it begins to get warm, although the water in the tank may be kept cool by very slow siphoning the water from a bucket through the cell and into another bucket.



Use cored carbons of highest grade, separated three-sixteenths to three-eighths of an inch and pointed before use.

The two carbons are set at an angle to the axis of the optical system, the lower one being a little in advance. This gives a very bright crater in the back focus of the condensers.

The arc is rather uncertain, however, and one can readily blow it out, a result which frequently excites considerable surprise.

The hottest or brightest carbon should be the positive and the upper carbon. If this is not the case, change over the terminals.

Continuous current consumes the positive carbon twice as fast as the negative, and the apparatus must be constructed to feed them together in that proportion. Alternating current consumes them alike.

Where used on a 220-volt motor, or a 500-volt street-car circuit a quickly-made, cheap and efficient rheostat is obtained by putting a board across the mouth of a wooden bucket and thrusting two carbons, to which the wires are fastened, through holes in the board, letting them dip into the water. Pushing them deeper into the solution gives more current, and adding salt will also increase the brightness of the light.



## FEATURES.

**I**N the construction of projecting apparatus it is well to observe that if the film is fed step by step, then the period of illumination must exceed the period of rest, and the greater the proportion between the two the more brilliant the illumination (if a shutter is used) or the sharper the picture (if no shutter is used). If the film is fed constantly then the projected rays must maintain practically parallel lines throughout the projection of each picture. Or rather, as before, the period of illumination must be as long as possible.

Let me again suggest that no shutter be used. It is a detriment, and adds nothing advantageous whatever. Rest assured, if your machine won't project satisfactory pictures without a shutter, its addition will not improve their brilliancy.

The modified Geneva stop or mutilated intermittent gear is very simple, and entirely efficient for feeding the film at speeds not exceeding, say, 20 pictures per second. Owing to its simplicity it will come into more general use than any other form of film-feeding mechanism. But it should be borne in mind that the proportion of movement to rest should, as pointed out, be maintained as small as possible.

But one pin in the driver on projecting machines should be used, while in the camera two may be employed with advantage.

It has frequently been asked whether it is possible to turn a camera by hand with such regularity as to secure a like exposure for each picture and uniform reproduction of the action in the projecting lanterns. The first question may be answered affirmatively, and needs no further explanation than that all properly constructed machines are provided with a balance wheel to give such regularity to the motion that no perceptible difference of exposure ever occurs except, possibly, at times, in pictures widely separated in the series.

The same can be said of the question of uniformity of action in reproduction except so far as it relates to its exact duplication, that is, that it shall transpire in the same unit of time. In this case supposing that the camera takes a given number of pictures per second, if they are projected at a rate of speed slower than that, then the performance pictured on the canvas will appear to occupy a longer time than in its completion; whereas if the projecting machine is turned faster than the camera was then the action will be quicker. And herein lies an advantage in favor of the hand-operated projecting machine, that is, that the lanternist as he watches the picture on the canvas has the exhibition entirely under his control and can turn the crank quickly or slowly, giving to the picture the effect of natural performance of the action involved. A piece of machinery can be photographed slowly and afterwards reproduced rapidly, thus falsifying the record. A train may be photographed while running over a known

course, at a rate of, say, sixty miles per hour. If this film is put through the projecting machine at twice the speed the train will appear to run at the rate of 120 miles per hour, and if no smoke or other extraneous objects are seen it would be difficult to prove that it did not run at that rate. The converse is also true. Photographs made, say, thirty-five per second (for kinoscope use), when reproduced in projecting machines feeding the film half as fast, produce a result startlingly comical. For instance, in a fisticuff encounter, when the knockdown blow is struck the vanquished fighter falls in the most leisurely manner imaginable. In fact, the blow itself appears to have been delivered with the greatest reluctance. These results certainly point clearly to the inability of a painter to portray action without supporting his principle subject with others in association. One knows a picture is intended to represent action only by the recollection of objects in life which the picture seems to resemble.

The available life of a film is greatly enhanced by keeping the picture surface as free as possible from the scratches or vertical streaks, and the little flashes of light where the gelatine has been pulled off in the tension, so noticeable after long runs. This is best done by the employment in projecting machines of a tension plate having the tension only along the edge of the film, that is, instead of using the common flat-lined tension, a pair of narrow polished metal strips are so located that they bear upon the edges of the strip over the holes. Springs are arranged to increase or decrease the tension at will, giving as much latitude in the pressure as in any other method. It will be found that a

tension of this kind on projecting machines very greatly enhances the life of the film. Such a device is of no especial benefit in taking pictures, as the film passes through the camera but once.

A new feature in this work which adds to the charm of a successful exhibition of some pictures consists in projecting with an ordinary magic lantern a view of the background while in the dark center moving objects alone are projected. The shakiness of the moving objects is then not nearly so noticeable, especially so since the background shows not the least vibration. This picture is more restful to the eyes, too. The pictures in which this method can be successfully employed are few, and probably would be confined to scientific work alone, but it adds greatly to the beauty and finish of the picture.

The same idea is carried out to wonderfully enhance the beauty of the moving pictures by exhibiting with the Phantoscope pictures on the black circle inside chromatic rings projected with a secondary lantern.

The beautiful effect seen upon the public stage of a girl dancing in colored lights, is reproduced with charming results, making, probably, the most gorgeous exhibit of all, but in tinting the ribbons for exhibition with different kinds of light it is well, in order to get the desired effect, to consider the quality of the illuminant employed, for after spending hours of hard and tedious labor in tinting the hundreds of little pictures, disappointment may result owing to the fact that the light is already impregnated with practically the same tint. The colors which experience has demonstrated as

generally best suited for tinting are the reds, pinks and greens—the warm end of the spectrum. As the opposite end of the spectrum is approached the tints have to be more deep to be readily distinguished upon the screen.

These pictures when projected upon a mist bank produce very pretty effects indeed, as the performance seems to be taking place in “thin air.” With properly constructed devices of this character and a powerful light, these images may be projected upon the clouds, producing thereon the same startling effect, but, of course, greatly intensified.

I have spoken of an automatic-actuated controlling device and the very simple one I use consists of two terminals of a broken circuit being held apart by springs the right distance to prevent a nickel coin passing while permitting a copper coin to drop through between them. When the proper coin is dropped into the gap between the terminals the circuit is completed and so remains furnishing current to run the motor, light the lamps, etc., until, say, a pin fastened to a suitable part of the mechanism shall have completed the circuit and striking against the terminal pulls it back against the spring, letting the coin drop through, breaking the circuit, stopping the motor, etc., and again resuming its position for the reception of a second coin. It is very simple and entirely satisfactory for small currents. For heavier current it should act as a relay to close a circuit actuating a heavy switch. A rather novel method of this kind for closing the large switch is to lay a piece of iron attached to the switch lever so that it shall come on top the motor armature shaft, and as soon as the circuit is closed through the motor magnetizing it, the

armature grips the strips of iron, advancing it and closing the switch and holding it closed until the current in the motor is broken, when, loosing its magnetism, the armature shaft allows the switch to fly open.

In crank machines the feed of the film, that is, the distance the pictures are pulled down each time, does not in the least depend upon the crank pin as one would at first glance suppose, but entirely upon the rotation of the sprocket wheel which takes up the slack. Thus if the sprocket did not rotate at all the crank pin might turn on forever without moving a single picture into position. However, the length of time that each individual picture shall remain at rest, that is, the proportion of rest to movement, depends entirely upon the location of the crank pin. This is readily seen if one imagines the pin located at the center of the crankhead, when it is obvious that there would be no period of rest at all, the film would be fed forward continuously, while moving the crank pin from the center begins to give an intermittent pull which increases as the pin is moved farther and farther from the center. Therefore, changing the size of the sprocket changes the size of the picture; changing the proportion of the gears connecting the sprocket and the crankhead shaft changes the size of the picture; but the period of rest of each interval depends wholly upon the distance of the pin from the center of the crankhead. A United States patent, No. 580,749, showing a mechanism of this kind, claims a rotating eccentric element and a feeding sprocket "connected by gearing so proportioned that the period of rest shall

exceed the period of motion," showing dense ignorance of the subject-matter by the alleged inventor.

A peculiarity of chronophotography is sometimes observed in pictures of wheeled vehicles. I have in mind a biograph picture of a response to a general fire alarm. As the engines dash past, the rear wheels appear to revolve slowly backward. It is a novelty in its way, and purely accidental, for obviously it would be impossible to secure such a picture by prearrangement, and thousands of attempts might be made without again obtaining a like result. The effect is optical and one of common demonstration in physical laboratories with a rapidly revolving Geissler tube intermittently illuminated, and is readily explained. The first picture was made when a pair of spokes of the engine wheel were, say, standing exactly vertical. Now the wheel and shutter of the camera so rotated that the second picture was made when the wheel was in such a position that a pair of spokes fell slightly short of a vertical position. In the third picture they fell slightly short of the position in the second, and so on throughout the series. When the pictures were projected upon the screen these successive positions were assembled upon the eye of the observer, producing the appearance of a wheel slipping on the ground and rotating slowly backward. This is not noticeable in the front wheel, which was turning at a different speed.

The aggregate time that a single picture on one of these long ribbons is in actual use is interesting. For instance, the average rate of projection of all the machines would probably be between twenty and twenty-five per second, say



twenty-five for purpose of illustration. The pictures are moved across the projected light in a series of steps, remaining at rest in the light two-thirds of an interval of both rest and motion. This causes each picture to be illuminated about  $\frac{1}{36}$  of a second. The average number of times a film may be used is frequently not more than 100, so that each individual picture is in useful employment not more than 3 seconds. But in kinoscopes, constructed to illuminate the picture but about  $\frac{1}{300}$  part of each revolution of the light-interrupting disc, and consequently to feed the pictures more rapidly, the results are even more startling. In this instance each picture is illuminated about  $\frac{1}{13500}$  part of a second. The film, however, lasts longer, say, for 1,000 successive runs, making the actual useful life of each picture less than  $\frac{1}{12}$  of a second. For this, \$25 used to be asked.

I once saw an animated picture which was entirely without shakiness, although the deception, when discovered, was the source of much merriment on the part of the audience. I had been invited to witness what purported to be the latest development in moving pictures. When the cue for this part of the entertainment was given, the usual white screen was rolled down at the back of the stage, and the lights turned down. The familiar whirr could be heard and when the light was thrown upon the canvas it revealed three dancing girls. Even from the first glance it did not seem quite right, and presently the whole scheme was distinguishable. The stage was a real stage, the girls were real flesh and blood specimens, and the whole was illuminated with an intermittently projected light in such realistic fashion that the

deception was almost perfect. It is needless to add that the audience was one of the most appreciative gatherings which ever accepted and enjoyed a brilliantly conceived joke.

The conclusion is sometimes reached by the persons watching an animated picture exhibit in the open air that the movement of the screen in the wind is the cause of the flickering and shakiness of the picture. Such is not the case, for no matter how the canvas is moved, the picture remains in the same place even though the canvas should travel continuously, say vertically, as a band, the picture would not be carried along by the movement of the surface upon which it was projected. Shakiness is chargeable alone to faulty construction of the film-feeding mechanism or inaccurate manipulation of the picture ribbon.

It may be interesting to know that if you are examining shaky pictures with an opera glass, reversing the glass, putting the large end next one, is restful to the eyes, although it makes the picture appear very far away.

The difference between flickering and shakiness of pictures is not generally understood. Shakiness or unsteadiness of the picture depends wholly upon the manner in which the picture ribbon is fed; thus, if the film moves intermittently and each picture moves exactly to the position occupied by the preceding picture, then there will be no shakiness of the picture on the screen,—it will be absolutely steady. On the other hand, if a shutter is employed and it is rotated too slowly a flickering or “winking” is produced which is entirely independent of whether a picture is being produced or not. Now suppose we run a shutter machine as usual, except that no

film is put in, that is, no picture is projected, the flickering is now just as much in evidence as before, although the illuminated square on the canvas is perfectly steady, having no movement whatever. If while watching this illuminated square of canvas, the machine is gradually slowed down, the flickering is more and more noticeable until the eyes begin to ache and one suffers great pain. If by force of will the observer continues to look at the canvas, unconsciousness and possibly insanity might result from the excruciating pain. Thus the remark frequently heard that some pictures are so shaky that they hurt one's eyes is erroneous, for, as just explained, no matter whether the pictures are shaky or not, if the machine is run fast enough, or the shutter is removed, no ill effect on the eye is noticeable. This injurious effect is probably due to the incessant contracting and relaxing of the muscles controlling the pupil of the eye. When the picture, or the light alone, as the case may be, is thrown upon the screen the eye immediately, and unconsciously to us, contracts so as not to admit too much light. The contraction is quickly followed by darkness as the shutter obscures the light of the lantern. The pupil immediately expands to gather as much light as possible. This is again followed quickly by light and consequent contraction, and again darkness and expansion, and so on until the eye fatigues from the excessive and unnatural exertion. No eye fatigue is ever experienced when a shutterless machine is employed, for the reason that darkness does not intervene during the changing of the pictures and consequently the pupil is motionless. Not only is a shutter

harmful but it is of no benefit in any manner. If the machine is so built that the period of rest of each picture is, say, three or four or more times longer than the period of substitution of the pictures, then the picture itself is so firmly impressed upon the retina of the eye that the impression of the smudge of the pictures changing places is imperceptible and the eye sees only the picture, and no matter how slowly the pictures are projected no fatigue of the eye is ever experienced. An impression of strong light on the retina of the eye so deadens the sensibilities that another impression is not possible until sensitiveness is again acquired by the retina. An impression may, however, be so very strong that the retina will not become sensitive again for days, as for instance, upon looking at the sun.

That the eye is the most wonderful organ of the human body is not likely to be denied by any one, but just how much it has to do with one's physical welfare will probably never be fully known. To chronophotography can be credited a demonstration on this subject worthy of note. Many persons while looking at a moving picture photographed from the front (or rear) of a moving train experience the same feeling of uneasiness which attacks them while traveling, and a photograph taken from the deck of a ship in rough water has been known to produce all the ill effects of genuine seasickness.

A picture ribbon which has proved popular with all audiences is a scene at the public baths of Milan. As pictured upon the canvas one sees the bathers walk out along the spring boards high above the water; there is a momentary

hesitation and then they dive off promiscuously and go plunging into the pool to the accompaniment of much splashing. This is very pretty indeed, but in a moment the operator feeds the picture through the machine in inverse order, with the following curious and amusing result: At first the water appears smooth, then there is a great splashing, followed by a smooth surface again out of which instantly shoot the bathers, feet first, one after another, singly and together, in startling confusion, and go sailing upward in graceful curves and ever decreasing momentum, just alighting upon the spring-board and back off down through the railing. If one has never seen this scene reversed it will be difficult to conceive the comical sight these bathers present popping out of the water feet first. The method employed to accomplish this astonishing result is simplicity itself. All the preparation necessary is to mount a rectifying prism in front of the projecting lens. A lantern slide, as is well known, to appear right side up on the screen must be put in the lantern wrong side up. This is equally applicable to the animated picture ribbon lantern. Consequently the strip is fed through the machine with the subjects standing on their heads. Now to begin at the other end of the ribbon, so as to make the order of events in inverse sequence, puts the ribbon through the machine the right way up,—heads up. But the picture on the screen is upside down. To invert it a prism is put in front of the lens, which rectifies the picture on the canvas.

In certain work, the above for instance, where the film is to be used without the addition of a prism, it is necessary

for the pictures to be reversed although maintaining their regular place in the series. This has heretofore generally been done by cutting apart the pictures in the negative strip, inverting them and splicing them into a long band of, say, a thousand pictures. From this negative positives are printed. Such a process is both very laborious and the register in the spliced strips uncertain. A far better method is the following automatic one: A special printer is constructed which feeds the negative and the unexposed sensitive film in synchronism, not in contact, as in ordinary practice, but separated far enough to put a lens (or, if reversing them right and left makes no difference, a prism) between them. This lens inverts the image. But if the films run in opposite directions so that the printing can be done with the films traveling continuously, a desirable method, the pictures remain in the same order as before. It is therefore necessary that the films travel intermittently in the same direction, the exposure being made while the two films are at rest. This gives the desired inverted image in the regular sequence, is quickly done and with precision.

A form of shutterless camera that can be advantageously used in experiments requiring extremely rapid exposures at irregular intervals is now employed for the measurement of the flight of projectiles. It depends upon the use of polarized light. The most efficient polariscope consists of a pair of Nicol prisms. When the prisms are crossed, that is, with the polarizer and analyzer planes at right angles, the light is totally extinguished. By rotating one of them, the analyzer for instance, light passes, increasing in intensity until the

planes of the prism are parallel. To accomplish the same ends without actually moving any mass, a transparent medium which can rotate the plane of polarized light is placed between the polarizer and the analyzer and made subject to the control of an electric current. The medium used is liquid carbon-disulphide contained in a brass tube with plain glass ends. This is very clear and colorless and possesses the necessary rotary power to a considerable extent when situated in a magnetic field, the rotary power being in proportion to its intensity. To produce the magnetic field a coil of wire is wound around the brass tube and an electric current passed through the coil. The prisms being crossed so that no light emerges from the analyzer, the current is sent through the coil, causing the rotation of the plane of polarization. When the current is broken the medium loses its rotating power and there is again complete darkness. If this intermittent light is caused to pass through a small hole in a disc fastened to a tuning-fork and photographed upon a moving actinically sensitive plate, an intelligible record is made thereof.

The catchy character of "life motion pictures" was soon recognized by advertisers and they were not long in availing themselves of the opportunity offered, and now one can scarcely visit a large city anywhere in America without finding an advertising stand employing moving pictures wholly or in part as their attraction. The methods in vogue are but simple modifications of ordinary lantern advertising practice. Usually there are two lanterns, one to project moving picture advertising films, while the other lantern is employed to fill

in the gap with single slide advertising pictures or pictures of purely entertaining character. Quite frequently a slide is used in the secondary lantern which projects above and below the moving picture on the screen the name of the article together with the address, etc., of the manufacturers. The moving picture is thrown upon the prearranged black blank on the screen.

A little "wrinkle," for rapidly producing announcements of current events, as war news, elections, etc., etc., on a lantern canvas, is to write the desired announcements with a typewriter, as needed, on transparent gelatine or film, and while the ink is still moist to dust it over with a tuft of cotton dipped in finely divided lamp black, soot, or the like. Mount so that there is an air space between the glass cover and the gelatine surface. The letters will appear in black against a white canvas.

The same method can be advantageously applied by engineers and draughtsmen in their blue printing. Thus, the impression of a rubber stamp on a tracing, as is well known, will not show on the blue print satisfactorily. If, however, lamp black is dusted on before the glycerine dries, the stamp will come out very plain indeed.

Making the lantern pictures on film negatives and joining them in a strip to be printed from, the positives afterward being joined to the moving picture strip, is a labor-saving scheme worthy of adoption, for the pictures can be drawn into position for projection, one at a time, afterward to be followed in regular order and without intermission by the moving pictures. A single lantern suffices when this method



is adopted, although to have two allows one lantern to cool while the other is in use. An arrangement for the secondary lantern which I have found to be very convenient in advertising lantern work is putting the slides in an endless chain by means of thin metal carriers in which the slides are held. These are made so that the slides are interchangeable, being easily and quickly inserted or removed from the carrier. A vertical attachment for the lantern is preferably employed. An automatic arrangement for changing the pictures adds to the convenience, and saves the expense of a helper.

In the projection of pictures in some situations, for instance, where the screen is much higher than the lantern, the picture will be "keystone-shaped." This can be remedied by inclining the picture slide in the carrier so that it shall stand in a plane parallel to the plane of the screen. This will cause a portion of the slide to be out of focus, but if the screen is not too high above the lantern, and the center of the slide is sharply focused, the top and bottom of the picture will be so little out of focus that no serious objection will be found thereto. Sometimes it is found impracticable to lean the slide-carrier forward to counteract the upward inclination of the lantern, in which case hanging the screen so that its bottom edge is drawn well back, making the plane of the screen and the plane of the slide-carrier parallel, will accomplish the same result with entire success and better focus.

The same principle may be applied in correcting a distorted negative. Thus, supposing a picture is unavoidably made with a camera without a swingback and of an object

above the level of the camera, the resultant negative is consequently distorted. Now make a copy in the camera having the negative not vertical, that is, leaning from or to the camera, as may be required. The result is a partially corrected positive. Now make a negative of this in same manner, *i. e.*, having the positive to be copied not vertical. The result will be a corrected negative from which right prints can be made direct. The resulting negative may be larger or smaller than the original, if desired, and accomplished during the above explained operation, and without extra exertion.

Among the other devices and methods which have naturally suggested themselves there is one intended to produce the same impression upon the senses of feeling through the medium of the eye which music does through the ear. A very crude instrument of this character was tried which projected colors, or rather a succession of colors upon a screen. Colors for projection are washed upon blank strips suitable for reproduction in the Phantoscope. These strips which were colored crudely represent the coarser or louder notes, and the soft colors or colors of short wave length to represent the soft tones. One readily remembers from youth having heard some colors designated as "loud" and others "soft." That is the idea exactly. The notes, half notes, etc., are represented by coloring different lengths of the tape to represent each. Thus if the tape is traveling at such a rate that a length of one foot of red shall represent a whole heavy note, then a length of six inches would represent a half note, etc. The loudness of the tone seems to depend upon the strength

of color. This will not quite hold, but illustrates the idea. I have found, however, that the persistence of vision which makes the Phantoscope a success is somewhat of a detriment in this instrument for the reason that, say, the eighths, sixteenths, etc., can not be readily reproduced owing to the fact that the eye will not quickly enough lose the impression of the preceding color, and for this reason I have been able to play only slow music, hymns, psalms, and the like, which friends who have seen the exhibit say is melancholy, gloomy and depressing enough to suit the most fastidious. Possibly, however, this difficulty might be overcome by neutralizing upon the retina the preceding color, or projecting such color that when superposed upon the preceding color will give the color desired. This color idea should not be lost sight of in tinting the picture ribbons, for the impression it is desired to convey by the picture is much easier given by the careful selection of the tints.

The question of copyrighting films to prevent their being copied has been the subject of much controversy, even with legal talent, and with many and varied conclusions. And until the matter is adjudicated, it is doubtful whether any one really knows what is necessary to secure protection; that is, whether recording the title alone is sufficient; whether short pieces of film will suffice, or whether to fulfil the requirements of law it is necessary to file two full length films of each subject. Does the title protect? The printed form of copyright reads as follows:

No. ———

LIBRARY OF CONGRESS,  
COPYRIGHT OFFICE, WASHINGTON.

*To wit: Be it Remembered,*

That on the ——— day of ——— anno domini 18——, C. Francis Jenkins, of Washington, D. C., has deposited in this Office the title of a Photograph, the title or description of which is in the following words, to wit:

“Soap Bubbles”

the right whereof he claims as proprietor in conformity with the laws of the United States respecting Copyrights.

—————, *Register of Copyrights.*

If no copies are filed the copyright is void and a penalty of \$25 incurred. Some have contended that if only a short piece of film is deposited with the title that this short piece might be cut out and the remainder of the film copied. The particular part protected could easily be detected, for that part must bear the stamp, and that part alone, under penalty of \$100 fine. Others have, however, contended that the resultant picture, the picture on the screen, is the only picture which could be copyrighted (though this is probably not tenable). And others again that the ribbons are neither photographs, according to the proper interpretation of the law, nor works of art, therefore not proper subjects for copyright. When the writer first called the attention of the Librarian of Congress to this matter he (the Librarian) positively asserted that these films were not proper subjects of copyright. Later, however, he admitted them for record. The subject has not yet been adjudicated and for the present “you pay your money and take your chances.”

Stereoscopic vision, or vision with two eyes, is of inesti-

mable value in the appreciation of form and solidity as well as the determination of distances. This interesting fact is properly valued and its advantages realized by a very few persons indeed. In fact by far the greater number are unaware that their sense of location is thus derived and are very much surprised and astonished when they realize that they approach a street curb with uncertainty and great caution if they close one eye.

That stereoscopic photographs are not more in favor is due probably as much as to anything else to the objectionable necessity of viewing them through a cumbersome stereoscope. However, the results are so far superior to the common photograph that this objection ought scarcely to have any great weight, and would seem to warrant the expenditure of much effort to make its use practicable in connection with moving pictures. To make the negatives requires no additional skill on the part of the operator, although a special double camera must be constructed, that is, a camera fitted with two lenses and capable of feeding at once two ribbons. Now after the positives have been printed therefrom the real problem presents itself, namely, to project the pictures so that the right eye will see only the picture made through the right lens of the camera and that the left eye shall see pictures made only through the left lens. It is therefore obvious that the oft-suggested method of projecting right and left pictures upon the screen will not give the desired effect, for the right eye not only sees the right picture but also the left picture, and vice versa, a wrong effect.

I have accomplished the desired result in three different

ways, first, a method which requires but one ribbon carrying alternately right and left pictures, second, the use of a ribbon having the two pictures thereon side by side, and third, a method adaptable alone to mutoscopic class of apparatus. The first method consists in exhibiting to the right eye in rapid succession, a series of right pictures of the moving object and during such exhibiting presenting to the left eye an approximately corresponding series of left pictures, whereby the object is perceived in relief and in motion. The sets of pictures may be made up of pairs of simultaneously taken right and left pictures and these may be simultaneously exhibited to the right and left eyes respectively. Neither condition is indispensable, however, and with the apparatus illustrated the impression upon the two retinas are made alternately. Preferably the two series of pictures are combined upon an ordinary strip of film, and under ordinary inspection neither the strip nor the pictures when projected are noticeably different from the ordinary film and pictures, although this film bears alternately right and left pictures. But if the projected pictures be viewed with the aid of devices which allow only right pictures to be seen by the right eye and left pictures to be seen by the left eye the moving object is seen in full stereoscopic relief. In the camera, negative film strips are made bearing right pictures and left pictures, respectively, and each having its pictures approximately a picture's height apart. These strips are superposed with the pictures of each set coming in the spacing between the pictures of the other, and with a third strip is then fed beneath a printing light, and thus both sets are printed upon the third

strip, which being properly developed, becomes the positive ready for use. The projected pictures may be viewed through an opera glass or any other binocular eyepiece adapted for alternately interrupting the lines of vision of the two eyes. The device is provided with a pivoted shutter. The shutter is swung back and forth synchronously with the advance of the pictures into the path of the beam of projected light in such manner that while a left picture is on the screen the view of the right eye is cut off and vice versa. This is accomplished by a current-reversing switch on the projecting machine connected with a solenoid in the eyepiece. If then the view of the right eye be unobstructed, and if the film be so placed that a right picture is projected, thereafter the whole series of pictures will be exhibited synchronously with the changes of the shutter, and the right and left eyes will see only the right and left pictures throughout the whole series of pictures as passed through the beam of projected light. Each eyepiece is attached to the back of the seat in front, and an insulated circuit entwines with the chain.

The modus operandi of the second method is to make in a stereoscopic moving picture camera two ribbons, one having all the left pictures and one having all the right pictures, without spaces between the pictures. These ribbons are developed, dried and fed closely side by side, one just touching the other, through a printer which prints a positive of twice the width of either of the negatives, having two vertical rows of pictures right and left. The pictures are projected upon the canvas and are viewed through a binocular eyepiece containing four total reflecting prisms so located that the right

picture comes to the right eye through the two prisms in front of the right eye and the left picture through the two prisms in front of the left eye. An adjusting device is provided which permits of the mental impression of the retinal images of the two pictures being exactly superposed at different distances. Mirrors will answer the requirements in the

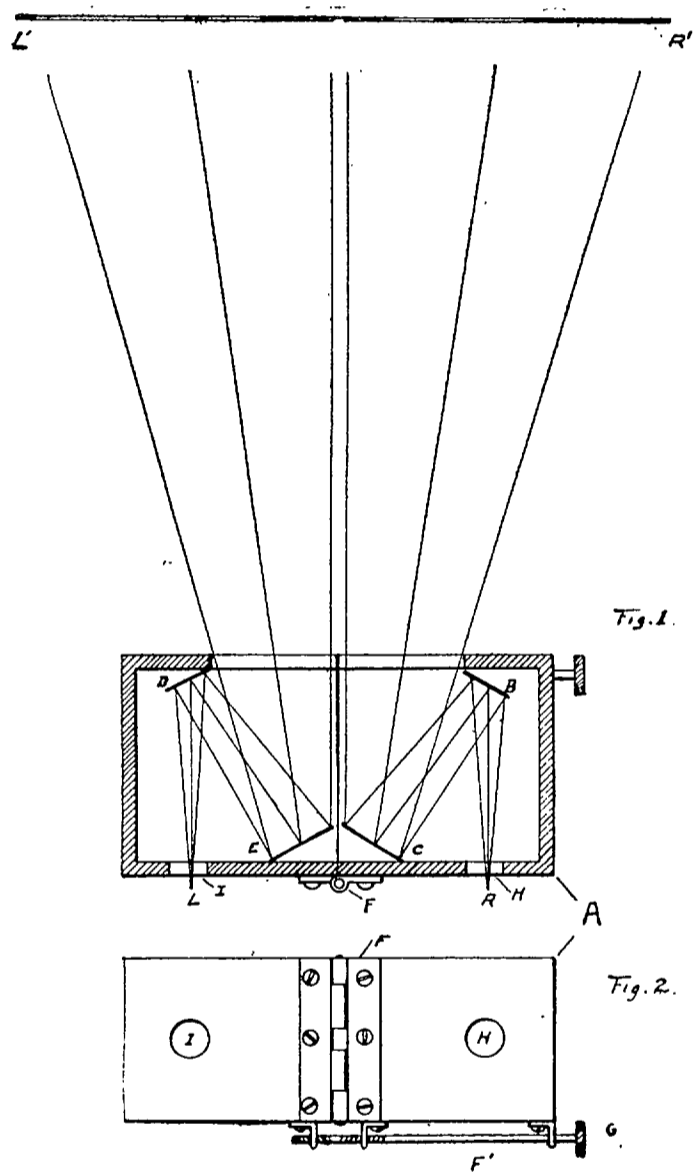

case entirely, with the single objection that the surface of the glass reflects somewhat, making the reflection from the silvered surface just a little hazy. This binocular eyepiece is even better adapted for viewing the stereoscopic pictures projected by an ordinary lantern. This device, with magnifying lenses added, has recently been placed on the market in connection with an album of large (8 by 10 and upward) stereoscopic pictures of great beauty.

The eyes are much more independent of each other in action than generally supposed. If one looks at a single object through this instrument, properly adjusted, the object appears natural. Now by turning the adjusting screw slightly two images appear. Only for a moment, however, for the eyes actually change the angle of vision without changing



focus. By turning the screw farther the angle can be still further changed, the eyes again assuming the new position. This can be continued in easy steps until the muscles fatigue, and relaxing resume their customary angle for that focus. It will then be noticed that there are two images very wide apart. (Incidentally engineers, microscopists, etc., who are accustomed to use the eyes more or less independently are able to decrease the angle of vision much farther than others.) This leads me to believe that by the use of this instrument the eyes of "cross-eyed" children can readily be corrected by the purely gymnastic exercise suggested above, and the few experiments made bear out the presumption.

In this connection it may not be amiss to mention an interesting observation in this line. To measure unaided the distance from center to center of one's own eyes, all that is necessary is to hold a pair of dividers (for rough experiments, the first and second fingers) the points three inches apart, before the eyes, meantime looking past them infinitely far into the sky. There will appear, indistinctly, four divider points. Gradually close the dividers until but three points are seen. The points are now exactly the width of the pupils, and represent the distance two stereoscopic pictures should be placed, from center to center, to be easiest viewed stereoscopically by the unaided eyes.

The binocular eyepiece is useful in many other ways, for instance, it enables one to look at an object with one eye and a sheet of paper with the other and to trace the image on the paper. The comparison in size or height or color of objects widely separated in the landscape is also possible. In

fact it seems to be a scientific instrument of considerable utility, aside from the beauty it adds to pictures.

The third method consists in mounting right and left pictures upon alternate cards, the latter all fastened at one end to a revoluble cylinder, for instance. Each right card has a notch on the right edge and each left card a notch on its left edge, say. These notches alternate, therefore, and alternately obscure the vision of the right and left eyes. The effect is very pleasing indeed.

It has quite frequently been suggested that the introduction of chronophotographic apparatus sounded the death-knell of the stereopticon, but with this opinion I do not agree. The fact is, the moving picture machine is simply a modified stereopticon or lantern, *i. e.*, a lantern equipped with a mechanical slide changer. All stereopticons will, sooner or later, as are several standard machines now, be arranged to project either stationary pictures or pictures giving the appearance of objects in motion. That these two features may be advantageously combined has recently been happily demonstrated.

Before the audience on the usual white canvas an announcement appeared reading: "A Pictorial Story. The effect of cycling, being a series of pictures representing the events and demonstrating the happy (?) termination of a bicycle courtship; the mind being prepared for the impression of the idea the picture portrays by music instead of a monologue-dialogue."

The first picture thrown upon the canvas shows a jolly party of cyclists in a grove. In the foreground a young man and maiden are being introduced to each other by a mutual

friend. The music (orchestra or piano) accompanying the picture is light and airy. The second picture shows the principals "far from the madding crowd" seated with their heads in suggestive proximity and with cycles leaning against a convenient tree. The music is soft and "spooney." For a honeymoon trip they visit Washington and also take a sea voyage. But they seek a home as other folks have done before them, and a picture entitled "Anticipation" follows. An inside view; a tandem in the background fitted with a baby seat; wife with baby on her knee, and wife and husband endeavoring to direct baby's attention to the little seat. The list continues and may consist of many or few pictures as desired, but when the list of magic lantern picture slides is completed it is followed by a Phantoscope picture showing a man and wife asleep at right, cradle at left with baby crying. Wife wakes and shakes husband, who reluctantly gets out, takes up baby and walks up and down. Steps on a tack and hops about the floor with baby on his arm like a wet rag and the injured foot in other hand. At this juncture a curtain appears to roll down upon the scene and the light vanishes.

Applause from the audience follows and in response there-to another picture is projected upon the canvas showing the same drop curtain. But presently it is drawn aside at the left and the principals appear, bow and back out again. Every one immediately recognized this as an encore picture, and the first time it was thrown upon the canvas the audience went wild over it. A second picture was projected in which the principals again appear leading the baby.

An exhibition of this kind was found to occupy an entire evening and at the same time present the attractiveness of a moving picture entertainment, but at much less expense to those having the entertainment in charge, which is sometimes desirable. Other picture plays introducing other stories illustrating a variety of shades of life were presented, the Phantoscope being introduced in the last few pictures of each series to relieve the monotony of a simple stereopticon entertainment with the interesting feature of a moving picture machine.

The scheme may be varied to suit individual or metropolitan tastes, and is given here as a suggestion to others interested in this very interesting art.

Another application of moving picture machines which is destined to prove of real benefit to humanity has been undertaken, and with entire success. An audience of deaf mutes are addressed from the canvas by a speaker many miles distant, or the same speaker may address a number of audiences at the same time. This accomplishment is due to the perfection of recently devised apparatus built especially for this purpose, and using wide film, fed with great smoothness. Portrait picture ribbons are made as the speaker, while seated in front of the camera, delivers his message. By means of the Phantoscope these lip-motion photographs are reproduced upon canvas, *i. e.*, a picture which actually speaks to one. The first experimental film of this character was made during the repetition of the Lord's prayer. The result was a ribbon two hundred feet long, containing about twelve hundred portraits, which, when reproduced upon the screen as one

simple portrait with lips moving as in speaking, presented nothing out of the ordinary to the layman, but to the educated deaf mute the moving lips proved of the utmost interest, conveying to his trained eye the very words of the original supplication.

To test the integrity of the reading the film was secretly reversed and run through the projecting machine backward, to the evident bewilderment of the reader, who but a moment before had deciphered the message so readily. Several seances were had later at which larger audiences were entertained, the pictures being read each time with entire success.

That these speaking lip pictures are destined to prove a boon to mutes was demonstrated beyond a doubt to every one who witnessed the appreciative enthusiasm of the entire audience. It was as though sealed lips had been released and deaf ears unstopped, a veritable liberation from bondage.

The work I have done in the new art (animated pictures) in the past seven or eight years, has been of the most fascinating character and has opened up wonderful possibilities along lines of purely scientific research. The time for such scientific investigation is certainly ripe. Those lines pointed out below, while not broadly new, all of them, are, with apparatus now obtainable, susceptible of splendid results.

For instance, a number of photographs of a growing plant, made, say, semi-daily or oftener, extending over the entire time covering the complete birth, growth, flowering, fruiting and decay of the plant, when reproduced on a large canvas by means of the Phantoscope, occur in the space of

a very few minutes and reveal to the eye with great vividness the phenomena of growing plants and the retarding or accelerating effect of humidity, pressure, temperature, sunshine, etc. Proper instruments for indicating these conditions of the atmosphere are photographed with the flower or plant studied, producing a record which in the projected pictures are seen simultaneously with the growth of the plant. Two plants growing together, but under varying conditions, say, one by artificial light and warmth and another by sunshine, are photographed and afterward reproduced side by side on the canvas, showing clearly the advantages or disadvantages of artificial propagation. As object lessons in botany these pictures prove of the keenest interest to the advanced student of science and ere long ought to develop results of great public benefit.

The same general plan of work could be carried forward under the microscope, the photographs to be afterward reproduced on the canvas to show the growth of a single petal, for instance. The movement of the blood in the capillary vessels could be shown on the canvas. Motion in the physical world as well as in the world of animated beings is an essential attribute of life, and the growth of animals, birds, microscopical germs, bacteria, microbes, etc., could be studied. Possibly there are interesting phenomena of a complex physical nature developing so slowly as to escape our observation under ordinary methods of investigation. Hypothetical deductions produce absurd results on occasions, and science is only exact measurement of observed phenomena. The changes in the human, say the changing animation of a growing baby's face,



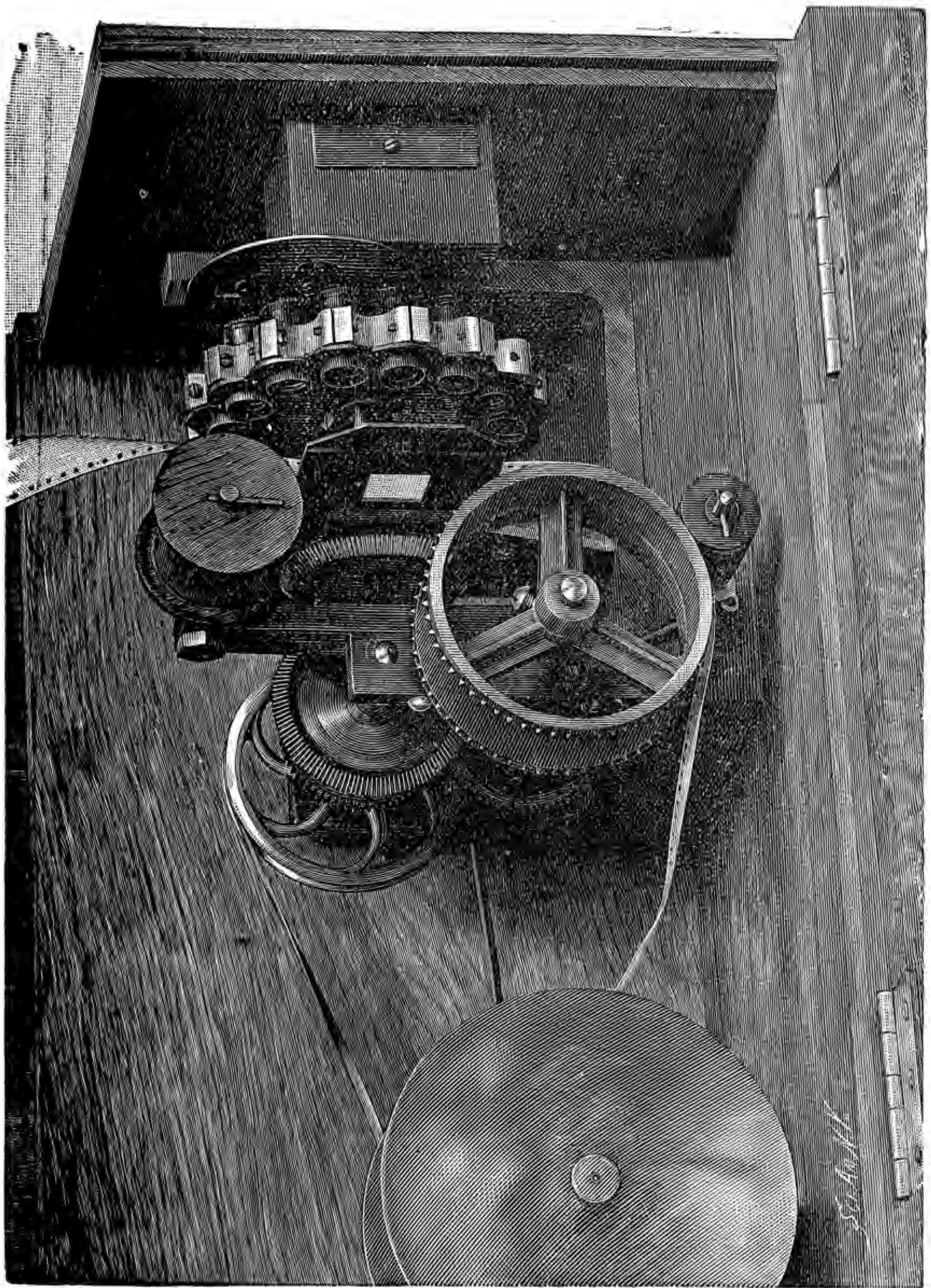



could be followed and recorded. The clouds in their ever-shifting forms also prove beautiful and interesting subjects.

My idea is to accelerate the record of very slowly developing processes until they are easily observed by an entire audience.

Another interesting application is the photographing of the same object, a plant, for instance, every minute between sunrise and sunset, which, when thrown upon the canvas, show the shifting shadows caused by the rapidly traveling sun from east to the western horizon, as well as the turning of the leaves to face their god all day and bow him out in the evening. The progress of the seasons is also thus shown in the space of but a few minutes, from photographs taken of a tree or a forest. One sees, while comfortably seated in a warm room, the white and barren fields of midwinter, the melting snows and budding leaves of spring, the waving of the mature foliage of summer, the changing to the browns and reds of autumn, and finally the falling leaves and barrenness of winter again.

Now the reverse, retardation, is just as interesting a subject of study. With my rotating lens camera I am able to take five hundred pictures per second with absolute precision, the while giving to each full-timed illumination. This enables me to photograph objects which move too rapidly to be seen or followed by the human eye. For instance, a dragon-fly's wings are photographed and afterward thrown upon the screen so slowly as to be easily followed and the movements of the wing determined. The rapid changes on the face of

the sun and its surrounding chromosphere could also be studied at one's leisure.

These exactly opposite methods produce entertaining results, but are tame beside the more startling and wonderfully interesting accomplishment secured with special apparatus, ray filters, and my new stereoscopic system.

A stalk of corn, say, is photographed with a compound camera through color screens day by day or hour by hour from the time it springs from the ground until it withers. These pictures are projected with a special lantern and are viewed by the audience through the new binocular eyepieces. Each onlooker sees upon the screen a green shoot spring up, sees it grow, sees its leaves or blades unfold, sees it put forth tassel and silk, sees it wither and decay, all in the space of two or three minutes. Nothing could be more interesting, it would seem. The growing stalk in all its beauty of form and color stands out from the screen, its height and location being as easily ascertained as though one were looking at the actual stalk of corn instead of a picture; surely a veritable realization of the philosopher's dream.





"THE DANCE"

Copyrighted "Lullaby" by  
Walter Scott & Sons,  
Chicago, Illinois, 1910.



## FORMULAS.

---

### DIRECTIONS FOR DEVELOPING EASTMAN'S NEGATIVE PHANTOSCOPE FILM.

#### **Pyro Formula :**

|                             |        |                               |        |
|-----------------------------|--------|-------------------------------|--------|
| Pyrogallic Acid . . . . .   | ½ oz.  | Sulphite of Soda (Crystals),  | 6 oz.  |
| Nitrous or Sulphurous Acid, | 20     | Carbonate of Soda (Crystals), | 4 oz.  |
| minims.                     |        | Water . . . . .               | 32 oz. |
| Water . . . . .             | 32 oz. |                               |        |

#### **To Develop,**

Take Pyro Solution, 1 oz.; Soda Solution, 1 oz.; Water, 8 oz.

#### **Restrainer.**

|                              |       |                 |       |
|------------------------------|-------|-----------------|-------|
| Bromide of Potassium . . . . | 1 oz. | Water . . . . . | 6 oz. |
|------------------------------|-------|-----------------|-------|

Restrainer is to be used only in cases of over-exposure.

As soon as developed rinse in three changes of water and apply a saturated solution of common alum for two minutes, then rinse again and fix.

#### **Fixing Solution.**

Hyposulphite Soda, 4 oz.; Water, 16 oz.

After fixing **wash thoroughly**, then apply for five minutes the

#### **Soaking Solution.**

Water, 32 oz.; Glycerine, 1 oz.

*Use no alcohol in soaking solution.*

DIRECTIONS FOR DEVELOPING  
EASTMAN'S POSITIVE PHANTOSCOPE FILM.

| No. 1.                                 | No. 2.                             |
|--|------------------------------------|
| Oxalate of Potash . . . . . 1 lb.      | Proto-Sulphate of Iron . . . 1 lb. |
| Hot Water . . . . . 3 pints.           | Hot Water . . . . . 1 ½ pints.     |
| Acidify with sulphuric or citric acid. | Sulphuric Acid . . . . . ½ dr.     |
| Test with Litmus paper.                | Or Citric Acid . . . . . ¼ oz.     |
| No. 3.                                 |                                    |
| Bromide Potassium . . . . . 1 oz.      | Water . . . . . 1 quart.           |

**To Develop,**

Take No. 1,—6 oz.; No. 2,—1 oz.; No. 3,—1 dram.

Mix in the order given. Use cold.

Allow the developer to act until sufficient density is obtained in the shadows; then wash well and fix.

When fixed wash thoroughly.

If there is any tendency to frilling apply a saturated solution of common alum.

Less of No. 2 will give less violent contrasts.

SEED DEVELOPING FORMULÆ.

**Pyro Developer:**

| No. 1.                               | No. 2.                              |
|--------------------------------------|-------------------------------------|
| Distilled or good well water, 16 oz. | Water . . . . . 16 oz.              |
| Sulphite of Soda (Crystals) . 4 oz.  | Sal Soda (Crystals) . . . . . 4 oz. |
| Pyrogallic Acid . . . . . 1 oz.      |                                     |
| Sulphuric Acid . . . . . 10 drops.   |                                     |

**To Develop,**

Take No. 1,—1 oz.; No. 2,—1 oz.; Water,—8 oz.

**Pyro Developer by Hydrometer Test :**

| No. 1.   | No. 2.                                 |
|--|--|
| Of a clear Sulphite of Soda solution to test 60 with Hydrometer, take . . . . . 18 oz. | Sal Soda Solution, Hydrometer test 40. |
| Pyrogallic Acid . . . . . 1 oz.  |  |
| Sulphuric Acid . . . . . 10 drops.   |  |

**To Develop,**

Take No. 1,—1 oz.; No. 2,—1 oz.; Water,—8 oz.

REMARKS.—More water gives flatness, and less water contrast. Use less water in cold weather.

In summer fix in freshly mixed hypo bath.

Dry quickly. An electric or hydraulic fan is excellent.

**EIKONOGEN-HYDROCHINONE DEVELOPER.**

| No. 1.                               | No. 2.                            |
|--------------------------------------|-----------------------------------|
| Distilled or pure well water, 32 oz. | Water . . . . . 32 oz.            |
| Sodium Sulphite (Crystals), . 4 oz.  | Carbonate of Potash . . . . 4 oz. |
| Eikonogen . . . . . 240 gr.          |                                   |
| Hydrochinone . . . . . 60 gr.        |                                   |

**To Develop,**

Take No. 1,—2 oz.; No. 2,—1 oz.; Water,—1 oz.

**By Hydrometer :**

| No. 1.   | No. 2.                                   |
|--|--|
| Sodium Sulphite Solution to test 30 . . . . . 34 oz. | Carbonate of Potash Solution to test 50. |
| Eikonogen . . . . . 240 gr.                          |  |
| Hydrochinone . . . . . 60 gr.                        |  |

**To Develop,**

Take No. 1,—2 oz.; No. 2,—1 oz.; Water,—1 oz.

More water gives less contrast and density.

**Fixing.**

A plain fixing bath, consisting of one part hypo to four parts water, may be used, but it is best then to immerse the film a few minutes in a

saturated solution of alum, and then rinse well and fix. The following chrome-alum fixing bath is recommended:

|                            |     |                          |
|----------------------------|-----|--------------------------|
| Water . . . . . 96 oz. } A | B { | Water . . . . . 32 oz.   |
| Hypo . . . . . 2 lbs. }    |     | Chrome-Alum . . . 2 oz.  |
| Sulphite of Soda . 4 oz. } |     | Sulphuric Acid . . ¼ oz. |
| (Crystals)                 |     |                          |

Pour B into A, while stirring A rapidly. As the chrome-alum dissolves slowly a stock solution of B can be made up.

DEVELOPING FORMULA FOR CARBUTT'S EUREKA RIBBON FILM,  
NEGATIVE AND POSITIVE.

|                                |                                 |
|--------------------------------|---------------------------------|
| Hydrochinon . . . . . 120 gr.  | Sodium Sulphite . . . . . 3 oz. |
| Methol . . . . . 80 gr.        | Bromide of Potass. . . . 30 gr. |
| Sodium Carbonate . . . . 2 oz. | Water . . . . . 64 oz.          |

Dissolve the Hydrochinon and Metol in warm water, before adding the Sodium Sulphite and Soda. This developer after once or twice using for negatives, may be used to develop the positive film. If on developing a test piece it is found to show the image in 30 to 40 seconds, the development should be stopped at the end of three minutes, rinsed off and examined for density; if not dense enough, return to developer for one minute, again rinse off, and fix in the following fixing bath:

|                                  |                                   |
|----------------------------------|-----------------------------------|
| Water . . . . . 128 oz.          | Hyposulphite of Soda . . . 2 lbs. |
| Sulphuric Acid . . . . . ½ oz.   | Chrome Alum . . . . . 1 oz.       |
| Sulphite of Soda . . . . . 4 oz. |                                   |

Mix in the order given, letting each ingredient dissolve before adding the next one; fix until all trace of unreduced Silver Bromide is dissolved.

ONE-SOLUTION PYRO DEVELOPER.

|                                      |                                |
|--------------------------------------|--------------------------------|
| Boiling Water (dist.) . . . 1 liter. | Carbonate of Soda . . 250 gms. |
| Sulphite of Soda . . . 500 gms.      | Pyro . . . . . 60 gms.         |

This solution is to be kept in well-corked bottles. For use, dilute with six parts water.



ESTABROOK'S PARA-HYDRO-QUINONE DEVELOPER.

No. 1.

Hydrochinone . . . . . 1 oz.      Paramidophenol . . . . . ¼ oz.  
 Dissolve in one quart of saturated solution of Sulphite of Soda.

No. 2.

Hydrate of Soda . . . . . 2 oz.      Water . . . . . ½ gal.

**To Develop,**

Take No. 1,—1 dram; No. 2,—2 ounces.

Larger quantities in same proportion.

METOL DEVELOPER.

Water . . . . . 30 oz.      Carbonate of Potash . . . ½ oz.  
 Metol . . . . . 75 gr.      Bromide of Potassium . . 10 gr.  
 Sulphite of Soda (Crystals) 1 oz.

GLYCIN DEVELOPER.

Potassium Carbonate . 160 gr.      Glycin . . . . . 40 gr.  
 Sodium Sulphite . . . . . 80 gr.      Water . . . . . 8 oz.

**To Develop,**

Take 100 mms. to 8 oz. Water.

ORTOL-SODA DEVELOPER.

|                                  |     |     |                                  |
|----------------------------------|-----|-----|----------------------------------|
| Water, cold . . . . . 10 oz.     | } A | B { | Water . . . . . 10 oz.           |
| Metabisulphite of Potash, 35 gr. |     |     | Carbonate of Soda . . . 1 ¼ oz.  |
| Ortol . . . . . 70 gr.           |     |     | Sulphite of Sodium . . . 1 ¾ oz. |
|                                  |     |     | Bromide of Potassium . 5-10 gr.  |
|                                  |     |     | Hypo Solution 5-10 . 50 mms.     |

For quick development take equal parts of each.

For soft negatives take one part each to one part water.

ORTOL-POTASH.

|                                  |                                   |
|----------------------------------|-----------------------------------|
| Water, cold . . . . . 10 oz.     | Water . . . . . 10 oz.            |
| Metabisulphite of Potash 150 gr. | Carbonate of Potash . . . 2 ½ oz. |
| Ortol . . . . . 300 gr.          | Sulphite of Sodium . . . . 6 oz.  |
|                                  | Bromide of Potassium . . 5-50 gr. |

To develop take one ounce each to twenty ounces water.  
 For very rapid development leave out Sulphite of Sodium.  
 The developer can be used over again and again until brown.  
 Use acid fixing bath.

**RODINAL DEVELOPER.**

Para-Amidophenal Hydrochlorate . . . . . 20 gr.  
 Metabisulphite of Potassium . . . . . 60 gr.  
 Potassium hydrate to neutralize  
 Water . . . . . 200 gr.

**To Develop,**

Dilute with forty parts of water.

**MIETHE DEVELOPER.**

|                                    |                              |
|------------------------------------|------------------------------|
| Sulphite of Soda . . . . . 35 gr.  | Hydrochinone . . . . . 7 gr. |
| Yellow Prussiate Potash . . 30 gr. | Water . . . . . 550 Cc.      |
| Caustic Potash . . . . . 30 gr.    |                              |
| Water . . . . . 550 Cc.            |                              |

**To Develop,**

Take three parts of each.

**PYRO-AMMONIA DEVELOPER.**

Pyrogallic Acid . . . . . 1 oz.  
 Sulphite of Soda, Saturated Solution . . 32 oz  
 Bromide of Potash, " " . 20 drops.  
 Ammonia, Concentrated Solution . . . 2 oz.  
 Water . . . . . 18 oz.

**To Develop,**

Take Pyro Solution . . . . . 12 oz.  
 Ammonia Solution . . . . . 4 drs.  
 Water . . . . . 36 oz.  
 Build up with Ammonia Solution as needed.

PYRO-ACETONE DEVELOPER.

|                              |           |                            |           |
|------------------------------|-----------|----------------------------|-----------|
| Water . . . . .              | 25 oz.    | Acetone Solution . . . . . | 2 1/2 oz. |
| Sulphite of Sodium . . . . . | 1 1/4 oz. | Pyrogallic Acid . . . . .  | 1/4 oz.   |

PARA-AMIDOPHENOL DEVELOPER.

|  |           |
|--|-----------|
| Para-Amidophenol Hydrochlorate . . . . . | 150 gr.   |
| Sulphite Sodium (Crystals) . . . . .     | 1 1/2 oz. |
| Potassium Carbonate . . . . .            | 1 1/2 dr. |
| Water . . . . .                          | 32 oz.    |

FOR CLOUD NEGATIVES.

|                           |         |     |     |                                  |        |
|---------------------------|---------|-----|-----|----------------------------------|--------|
| Hydrochinone . . . . .    | 1 oz.   | } A | B { | Potassium Carbonate . . . . .    | 1 oz.  |
| Sodium Sulphite . . . . . | 5 oz.   |     |     | Potassium Ferrocyanide . . . . . | 1 oz.  |
| Water . . . . .           | 25 oz.  |     |     | Water . . . . .                  | 12 oz. |
| Alcohol . . . . .         | 1/4 oz. |     |     |                                  |        |

To develop take 3 oz. of A and 1 oz. of B, and add 12 drops of a 10 per cent. solution of Bromide.

INTENSIFIER—MERCURY.

Prepare a saturated solution of Bichromate of Mercury. Run the film through this repeatedly until it has the proper density. Then pour the solution back into the bottle, as it can be used again and again until it has lost its strength. Rinse and blacken with a ten per cent. solution of Ammonia until the color is entirely through on the back. Wash thoroughly.

INTENSIFYING WITH SILVER.

Prepare the following stock solutions:

|                          |         |                                 |         |
|--------------------------|---------|---------------------------------|---------|
| Silver Nitrate . . . . . | 1/4 oz. | Ammonia Sulphocyanide . . . . . | 1/2 oz. |
| Water . . . . .          | 3 oz.   | Hyposulphite of Soda . . . . .  | 1/2 oz. |
|                          |         | Water . . . . .                 | 2 oz.   |

To use, add the Ammonia solution to the Silver solution until the precipitate is just redissolved; to each ounce of resultant solution add 1/2 oz. Pyro stock solution, five minims Ammonia and half a grain of Bromide. In this redevelop until the desired intensity is secured. Immerse in fresh fixing bath for five minutes, and wash. To prevent frilling, first use Alum.

REDUCER.

Dissolve one part Red Prussiate of Potash in fifteen parts water. Use light-proof bottles. Immerse negative in a Hypo solution (one part Hypo

to fifteen parts water) to which has been added a little of the above immediately before use.

ANOTHER METHOD: Soak the film in Hypo solution and paint with saturated solution Ferricyanide of Potassium in ten parts water.

ANOTHER: To one part Hypo add one part Ferrous Oxolate and dilute if desired. Flow or paint.

ANOTHER: A 5 per cent. solution of Ammonium Persulphate the author finds a most excellent reducer for full plate and local work.

#### CHROMATIC COLORS.

For Red . . . . . Eosine.  
For Green . . Methyl Orange and Iodine Green.  
For Blue . . . . . Methyl Blue.  
For Yellow Screens . . Picric Acid.

#### HYPO ELIMINATOR.

Use three per cent. solution of Bromide of Potassium.

#### TO REMOVE PYRO STAINS.

Hydrochloric, Citric or Oxalic acid added to washing water removes Pyro stains from fingers or clothing.

#### SILVER STAINS.

A solution of one part of Iodide of Potassium in twenty parts water is recommended for removing Silver stains from negative or positive films.

Or, 1 oz. Alum, 1 oz. Sulphuric Acid, 3 oz. Sulphate of Iron in 20 oz. of Water. After clearing, wash thoroughly.

#### JENKINS' SPLICING SOLUTION.

Commercial Collodion . 80 parts. Ether . . . . . 20 parts.

The above can not be excelled, although Acetone and Amyl Acetate as mending solutions are recommended by some operators.

#### FORMALINE AND ALUMINUM CHLORIDE.

A 10 per cent. solution of Formaline is coming into use as a hardener for gelatine films; followed by a soaking solution to give flexibility, although the author prefers a solution of Aluminum Chloride, which is free from any deleterious effect to the operator.

### TO RECOVER FOGGED FILMS.

Saturate the film thoroughly in

Bromide of Potassium . . . . . 125 gr.  
Chromic Acid . . . . . 35 gr.  
Water . . . . . 25 oz.

Or in

Hydrochloric Acid . . . . . 4 dr.      Water . . . . . 20 oz.  
Bichromate of Potash . . . . . 2 oz.      Sulphuric Acid . . . . . 5 drops.

### INDESTRUCTIBLE INK FOR LABELLING BOTTLES.

Into 150 cu. cent. Lamp Spirit stir 20 grams brown Shellac. Pour slowly into a solution of 35 grams Borax in 250 cu. cent. Water, to which add, say, one gram Methyl Violet.

### TO PRESERVE LABELS.

Paint the label with bees' wax and rosin, equal parts, hot. Hot parafine will answer, but not so well.

### AN ADHESIVE FOR CLOTH TO METAL.

Tragachauth . . . . . 30 gr.  
Gum . . . . . 120 gr.  
Water . . . . . 500 Cc.

### LEATHER COLLODION.

Collodion, 25 parts to Castor Oil, 1 part.

### WATERPROOF CEMENT.

Bichromate of Potash . . . . . 8 parts.  
Gelatine Size . . . . . 11 parts.  
Alum . . . . . 1 part.

### RETOUCHING VARNISH.

To Sandarac, say, add 2 oz. Alcohol to cut and make the right thinness. To 16 oz. add 1 oz. Oil of Lavender to toughen.

### TO TRANSFER CUTS.

The ink of newspaper and magazine cuts can be softened with a solution of

Yellow or Soft Soap . . . . . 2 oz.  
Hot Water . . . . . 16 oz.

When cold add

Turpentine . . . . . 16 oz.

The picture in its original colors can then be transferred by pressure to an unexposed developed lantern slide.

### BLUE PRINT SOLUTION.

Citrate of Iron and Ammonia . . . . .  $1\frac{7}{8}$  oz.  
Water . . . . . 8 oz.

Ferricyanide of Potassium . . . . .  $1\frac{1}{4}$  oz.  
Water . . . . . 8 oz.

Mix equal parts just before use. Paint desired surface with broad brush and hang up in dark to dry.

### PAPER SENSITIVE TO LIGHT.

Commercial papers sensitive to light are obtainable at any stock house. Bichromatized paper, without pigment, is made by flowing with 10 per cent. gelatine, and after drying sensitized with 10 per cent. solution Bichromate of Potash or Ammonia. Dry in the dark.

### PAPER SENSITIVE TO HEAT.

Bichromatized paper (without pigment) should be dipped, after exposure and development, in a very dilute solution of Sulphuric Acid, say, fifty drops in one oz. of water. When dry it is colorless, but heat brings out the image very black.

### PAPER SENSITIVE TO MOISTURE.

Bichromatized paper (without pigment) should be dipped, after exposure and development, in a ten per cent. solution of Chloride of Cobalt. In damp weather the image is scarcely visible, but in dry weather it is a bright blue.

## PAPER SENSITIVE TO ELECTRICITY.

Saturate paper with the following solution :

|  |  |
|--|--|
| Nitrate of Ammonia . . . 3 oz.               | Ferro-cyanide of Potassium $\frac{1}{4}$ oz. |
| Muriate of Ammonia . . . 1 $\frac{1}{2}$ oz. | Water (fluid ounces) . . . 16 oz.            |

The presence of iron through which a current of electricity is passing will cause that part of the paper or image to turn blue.

## WATER PICTURES.

Bichromatized paper (without pigment) dipped, after exposure and development, in a solution of Sulphurous Acid will bleach. Let it dry and no image appears. Immersing in water will again bring out the image.

## WEIGHTS AND MEASURES.

| Apothecaries.                  | Conversions.                  |
|--------------------------------|-------------------------------|
| 1 pound . . . . . 12 ounces.   | 1 cu. cent. . . . . 1 gram.   |
| 1 ounce . . . . . 8 drams.     | 1 kilogram . . . . . 1 liter. |
| 1 dram . . . . . 3 scruples.   | 1 dram . . . . . 60 grains.   |
| 1 scruple . . . . . 20 grains. | 1 gram . . . . . 16.5 minims. |
| <b>Avoirdupois.</b>            | 1 dram . . . . . 4 cu. cent.  |
| 1 pound . . . . . 16 ounces.   | 1 gram . . . . . 15.5 grains. |
| 1 ounce . . . . . 16 drams.    | 1 liter . . . . . 34 ounces.  |
| 1 dram . . . . . 27.34 grains. | 1 dram . . . . . 4 grams.     |
| <b>Fluids.</b>                 | 1 gram . . . . . 32 ounces.   |
| 1 pint . . . . . 16 ounces.    |                               |
| 1 ounce . . . . . 8 drams.     |                               |
| 1 dram . . . . . 60 minims.    |                               |

## A SIMPLE DESCRIPTION OF THE WET PLATE PROCESS.

The plates to be used should first be thoroughly cleaned by placing them in Nitric or Sulphuric Acid, and afterward washed.

To Albuminize them take the white of one egg and fifteen ounces of water with some broken glass in a bottle and shake well to cut the Albumen and thoroughly mix. Pour the Albumen upon one corner and flow over the clean, moist plate. Set in rack to dry.

The Collodion solution is made of Alcohol 16 ounces (by measure), Ether, 16 ounces (by weight), Gun Cotton 160 grains, Iodide of Ammonium 80 grains, and Bromide of Cadmium 30 grains.

The Sensitizing solution is made by taking as much water as is needed for the bath, say 16 ounces, in a bottle. Into this drop crystals of Nitrate of Silver and dissolve until it tests 45° by hydrometer. Set this bottle in the sun until the organic matter, turning first red and then black, precipitates as mud at the bottom. Into another clean bottle of the same size filter half the Silver solution. Now take of Iodide of Ammonium a few grains in a graduate and shake up with enough water to dissolve it. Of this add to the unfiltered solution a few drops at a time until the milky solution formed refuses to clear, which means that it is over-iodized. Filter this into the first-filtered Silver solution.

Dust off an Albumenized plate, and holding it horizontally by one corner, pour on the Collodion at the corner, preferably from a pouring bottle, flow over the plate and pour the excess back into the bottle. Pinch off the drop at the corner and when the Collodion sets, put into the Silver bath. Leave it there from three to five minutes until by the darkroom light it looks smooth and creamy all over, and it is ready to put into the plate holder.

The plate requires an exposure fully ten times as long as the ordinary commercial gelatine plate.

Have ready a developer made of Sulphate of Iron in water to test 20°, and add, say, one-half ounce Acetic Acid to each pint of developer. Holding the plate horizontally, pour on at right hand corner and allow the developer to flow back and forth until the image is fully developed. Then fix in hypo and wash and dry. Unless the plates are to be used again, varnish them.

#### TO INTENSIFY WET PLATES:

|                                    |                                  |
|------------------------------------|----------------------------------|
| Sulphate of Copper . . . . . 1 oz. | Bromide of Potassium . . . ½ oz. |
| Water . . . . . 8 oz.              | Water . . . . . 8 oz.            |

Take equal parts of each and pour over the well-washed plate. The film will turn a creamy white. Wash well, and flow with a solution of Nitrate of Silver 35 grains to 1 ounce of clear water. Wash and dry.





. . . DIRECTIONS FOR USING . . .

# EASTMAN'S SOLIO PAPER

## COMBINED TONING AND FIXING BATH.

Print a little darker than finished prints should be and place prints without previous washing in the following combined toning and fixing bath:

4 oz. Eastman's Solio Toning Solution.  
8 oz. Cold Water.

Twelve ounces diluted toning solution will tone four dozen 4 x 5 prints.

When proper shade has been attained transfer for five minutes to short stop.

Salt, - - - - - 1 oz.  
Water, - - - - - 32 oz.

Wash one hour in running water, or in 16 changes of water.

If desired the combined toning bath may be made up as follows:

Stock Solution: **A** Hyposulphite of Soda, - - - 8 oz.  
Alum, (Crystals) - - - 6 oz.  
Sugar, (granulated) - - - 2 oz.  
Water, - - - - - 80 oz.

Dissolve above in *Cold Water*, and  
When dissolved add Borax 2 oz.  
Dissolved in hot water, 8 oz.

Let stand over night and decant clear liquid.

Stock Solution: **B** Pure Chloride of Gold, - - - 7½ grains.\*  
Acetate of Lead, (Sugar of Lead) 64 grains.  
Water, - - - - - 8 oz.

Solution B should be shaken up before using and not filtered.

To tone 15 Cabinets take:

Stock Solution A, - - - - - 8 oz.  
Stock Solution B, - - - - - 1 oz.

Place prints without previous washing into the above.

Tone to desired color and immerse prints for 5 minutes in following Salt Solution to stop the toning.

Salt, - - - - - 1 oz.  
Water, - - - - - 32 oz.

The extra fixing bath should be used to ensure *thorough fixing*.

After the salt bath give one change of cold water and fix for ten minutes in the

EXTRA  
FIXING  
BATH: Hyposulphite of Soda, - - - 1 oz.  
Sulphite of Soda, (Crystals) - 60 grains.  
Borax, - - - - - ¼ oz.  
Water, - - - - - 20 oz.

**Wash** 1 hour in running cold water or in 16 changes of cold water, when prints may be mounted same as albumen prints.

**The combined bath must be used cold**, not above 50° Fahr. This condition can be obtained by placing a piece of ice in the bath when toning. If your bath is too warm, you will get yellow prints with a greenish cast in the half tones.

**Use a Thermometer** and keep it in your toning bath all the time.

**The combined bath is an acid solution.** The borax neutralizes only the *excess* of acid in the alum. Any attempt to neutralize the bath will precipitate the alum.

The combined bath should not be used a second time.

**Clean Trays** once a week with nitric acid or sulphuric acid and water to prevent white spots or blotches on the prints.

\*Or double the quantity of chloride of gold and sodium.

## SEPARATE BATH FORMULA.

(USE SOLIO HARDENER IN FIXING BATH.)

**Wash** in 5 or 6 changes of water or sufficient to remove the free silver.

**Tone** in a plain gold bath, using about 1 gr. of gold to 48 oz. of water. Neutralize by adding a saturated solution of borax, bi-carbonate of soda or sal soda.

When toned, immerse prints in running water where they may remain until all are ready for the fixing.

If running water cannot be had put prints into

|              |                  |        |
|--------------|------------------|--------|
| <b>SHORT</b> | Salt, - - - - -  | 1 oz.  |
| <b>STOP:</b> | Water, - - - - - | 1 gal. |

If there is a large batch of prints to be toned do not allow prints to lie in short stop solution, but put them into a tray containing clear water where they may remain until all are ready for the fixing.

**Fix Twenty Minutes in**

|                           |        |
|---------------------------|--------|
| Water, - - - - -          | 1 gal. |
| Hypo, - - - - -           | 13 oz. |
| Solio Hardener, - - - - - | ½ oz.  |

**To Mix With Hydrometer**, take water 1 gal., add sufficient Hypo to test 25 gr. to the oz., and add ½ oz. of SOLIO Hardener.

**Wash** 1 hour in running cold water or in 16 changes of cold water, keeping prints separated so the water may have a chance to eliminate the chemicals.

## DETAILS.

The toning bath should tone in 6 or 7 minutes.

Tone by transmitted light for the high lights and half tones only, paying no attention whatever to the shadows.

We recommend a neutral bath and advise the use of Squibb's red litmus to test with.

If the bath tones uneven or streaky, add water until it tones in 8 or 10 minutes, and make it slightly alkaline.

One gallon of fixing bath is sufficient for 1 gross cabinet size SOLIO or its equivalent.

Solio Hardener powders put up by the manufacturers of solio paper can be obtained from all stock dealers.

**GLACE FINISH.**—Clean the ferrotype plate with warm water each time it is used. Polish with a soft cloth until plate is absolutely free from dirt or specks of any description. Swab with a tuft of soft cloth or cotton batting wet with a solution composed of benzine 1 oz., paraffin 10 gr. Rub dry with a clean cloth and polish with a chamois skin or very soft cloth. Use a soft brush to remove particles of dust. Then squeegee the wet print on to the plate and rub down with a dry blotter. The print must be in perfect contact to produce a uniform and even surface. This can be obtained by placing a piece of cotton or rubber cloth over the print and using a small print roller to rub down.

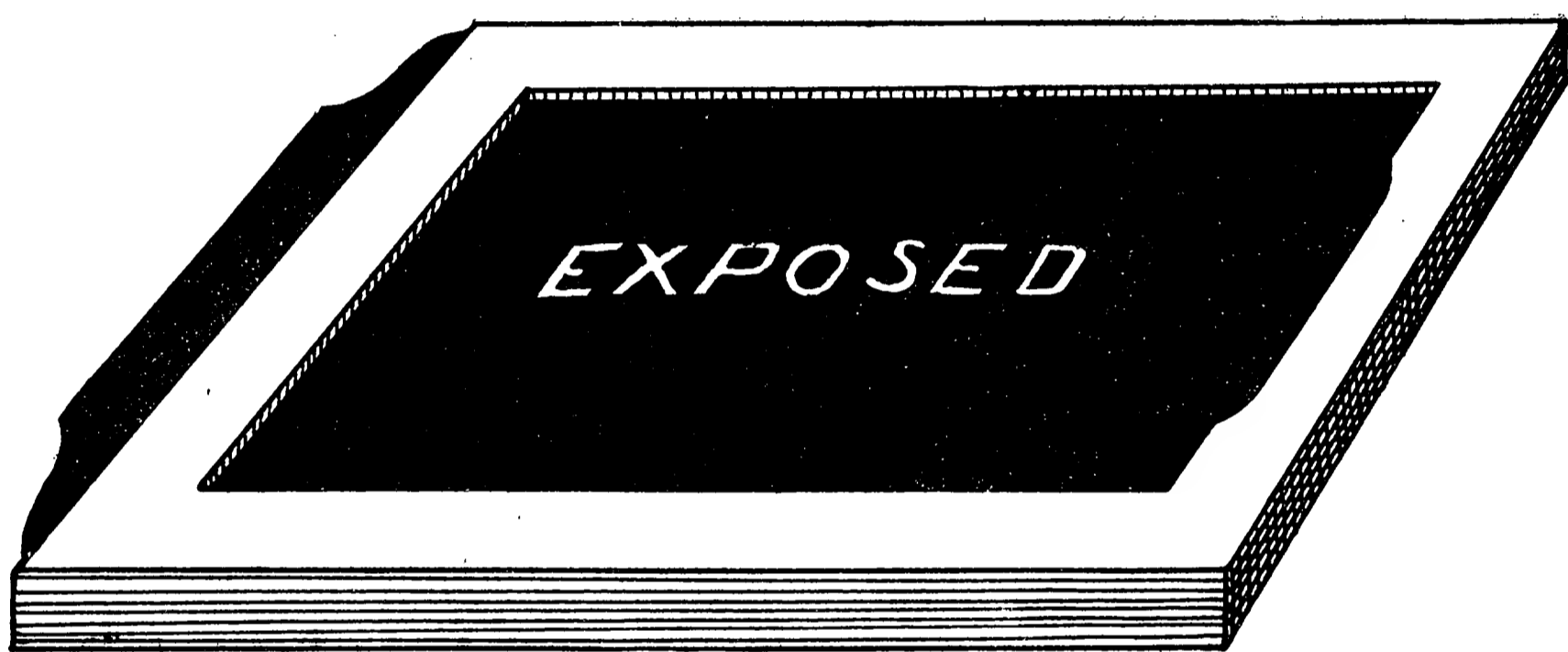



ENGRAVED HALF-TONE BY  
GEO. H. BENEDICT & CO., CHICAGO.



I AM INDEBTED TO MR. WALTER E. WOODBURY FOR CUTS  
ON PAGES 9, 35, 38, 39, 54, 58 AND 62, AND TO *Scientific  
American* FOR THOSE FACING PAGES 15, 72, 73 AND  
105, AND TO O'KEEFE & STOCKDORF FOR THAT FACING  
PAGE 1.

NEGATIVE

AND POSITIVE



TRANSPARENT

FILM

FOR "ANIMATED PICTURE"  
MACHINES IN ANY WIDTH.

EASTMAN'S FILM DOES NOT FRILL.



EASTMAN KODAK COMPANY,

ROCHESTER, N. Y.

# EYANSON & ARMPRIESTER,

Commerce Street, Cor. of 7th,

PHILADELPHIA.

MANUFACTURERS OF

## Switch Boards, Switches and Distributing ✿ Boards ✿

---

Besides our regular Manufacturing Business we have entirely separate from our factory one of the Best Equipped **Physical** and **Chemical** Laboratories in this country. We are especially equipped for conducting Electro-Chemical experiments.

---

Try us and get the benefit of our Machine Shop and Laboratory.



*Seein' Things at Night.*—EUGENE FIELD.

# The Criterion Acetylene Gas

Generator furnishes the new and wonderful

Illuminant,  
Both  
Superior in Quality  
and  
Cheaper in Cost  
than any other  
Artificial Light  
known.  
Positively Safe.

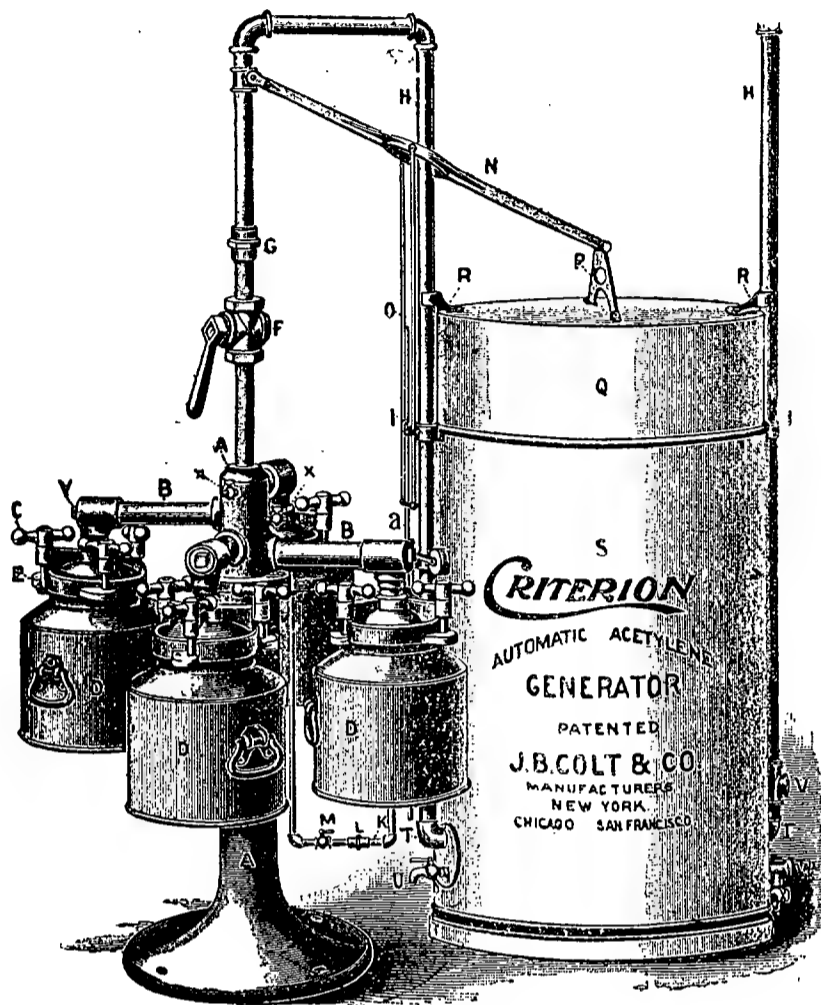

Suitable for nearly every purpose where an Artificial Light is required, from a Magic Lantern to an entire building or any number of buildings. Send for information.

## Speak Quick

for a STEREOPTICON at HALF-PRICE.

We are selling our large and complete Stock of Magic Lanterns, Stereopticons, Slides,

and  
Accessories at  
greatly  
Reduced  
Rates.

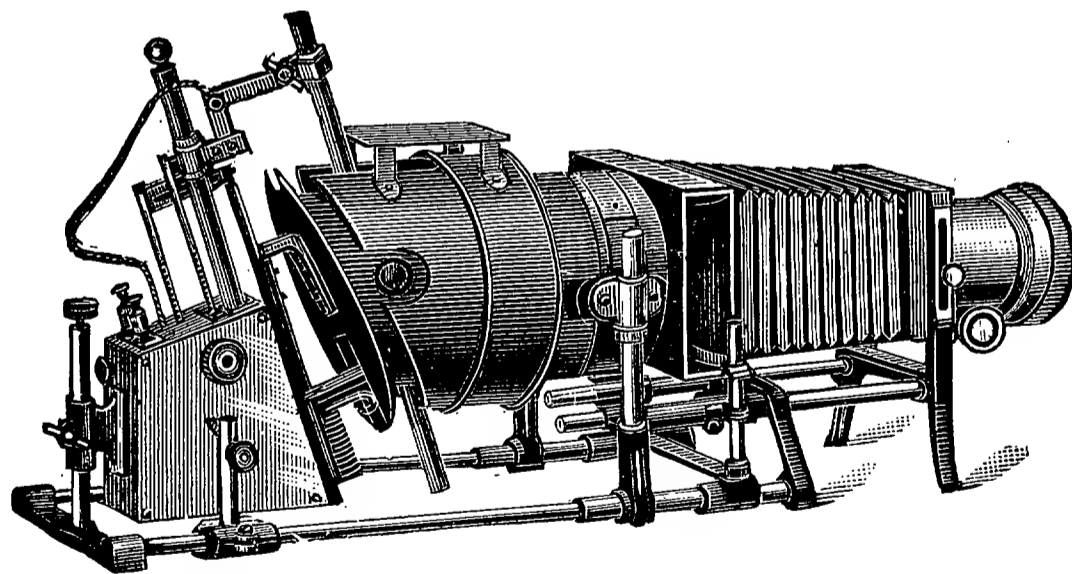

NOW is the time to secure an Unprecedented Bargain.

Write for our "Bargain" Circular and mention "Animated Pictures."

**J. B. COLT & CO.,**

3 to 7 W. 29th St.,

NEW YORK.

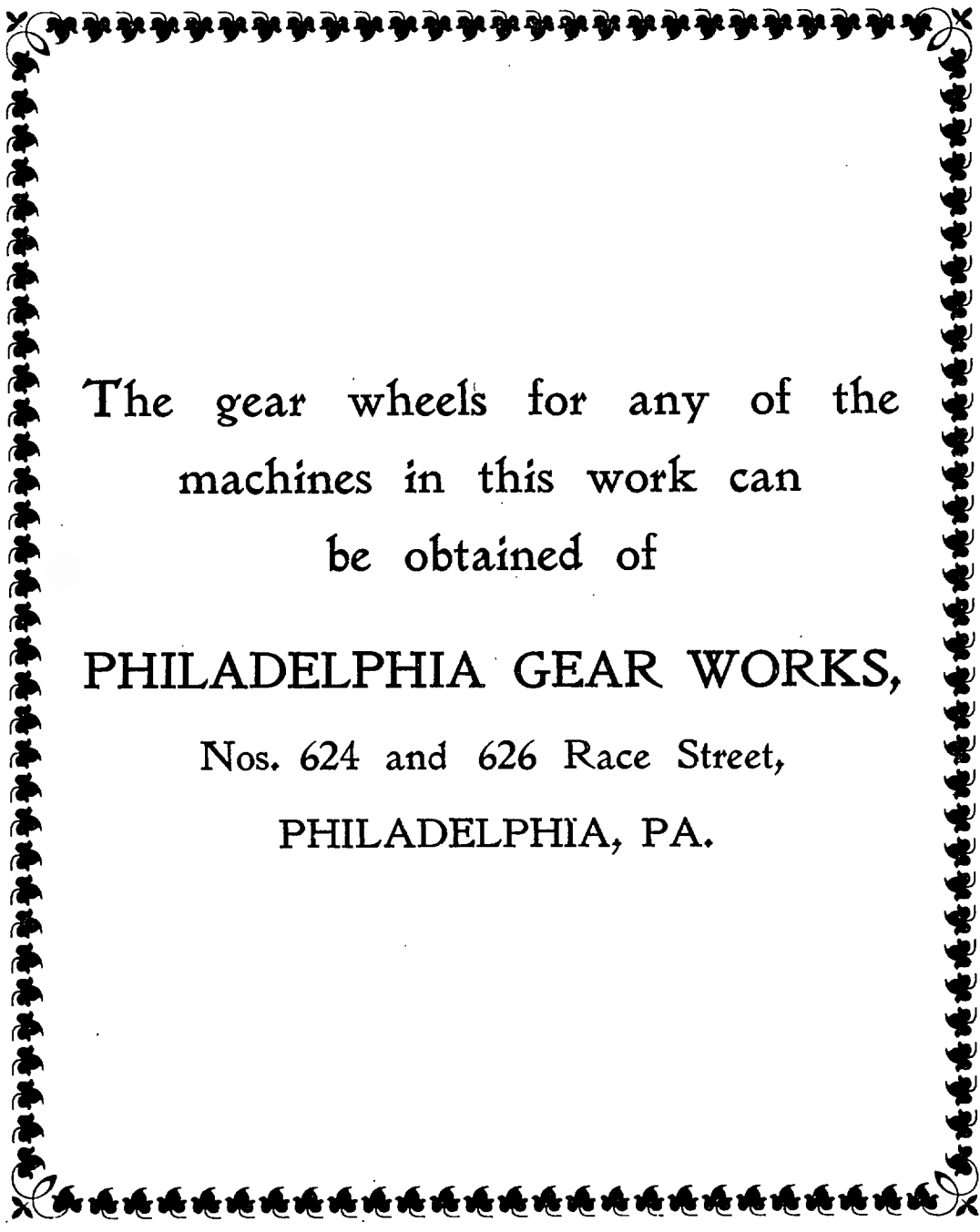
A decorative border consisting of a repeating floral or leaf-like pattern, forming a rectangular frame around the central text.

The gear wheels for any of the  
machines in this work can  
be obtained of

**PHILADELPHIA GEAR WORKS,**

Nos. 624 and 626 Race Street,

PHILADELPHIA, PA.

# M. DUPEROW,

527 Fifteenth Street Northwest,

WASHINGTON, D. C.

## General Electric Supplies.

Electricity Direct from Heat.

Medical Batteries.

Telegraph Apparatus.

Telephone Apparatus.

Insulated Wire.



Burglar Alarms.

Fan Motors.

Dynamos.

Electroliers.

---

## SCIENTIFIC AMERICAN.

THE MOST POPULAR SCIENTIFIC PAPER IN THE WORLD.

Established 1845.

Weekly, \$3 a Year; \$1.50 Six Months.

**T**HIS unrivalled periodical is now in its **fifty-second year**, and, owing to its everincreasing popularity, it enjoys the largest circulation ever attained by any scientific publication. Every number contains sixteen large pages, beautifully printed, handsomely illustrated; it presents in popular style a descriptive record of the most novel, interesting and important developments in Science, Art and Manufactures. It shows the progress of the World in respect to New Discoveries and Improvements, embracing Machinery, Mechanical Works, Engineering in all branches, Chemistry, Metallurgy, Electricity, Photography, Light, Heat, Architecture, Domestic Economy, Agriculture, Natural History, etc. It abounds in fresh and interesting subjects for discussion, thought or study. It provides material for experiment at home and in the laboratory, and it enables the intelligent reader to keep informed as to the industrial and scientific development of the country. Terms, \$3.00 a year; \$1.50 six months. Specimen copies free. Remit by Postal Order or Check.

MUNN & CO., Publishers, 361 Broadway, N. Y.

---

## SCIENTIFIC BOOKS

of every kind promptly furnished by Munn & Co., Publishers of THE SCIENTIFIC AMERICAN, 361 Broadway, New York. Book Catalogue sent free.

WE ARE EQUIPPED FOR ALL KINDS OF

EXPERIMENTAL  
WORK

Bring

or

Mail

us

a

Sketch

of

What

You

Want.

---

Understand the Art of Making Moving  
Picture Machines.

---

DOREMUS & JUST CO.

Manufacturers,

414 Eleventh Street N. W.      Star Building,

WASHINGTON, D. C.

# CARBUTT'S

## Eureka

Cable Address :  
Carbutt, Philadelphia.

## Ribbon Film

FOR USE IN ALL

### CHRONOGRAPHIC CAMERAS AND PROJECTING ANIMATED PICTURE MACHINES

MADE ON

CLEAR, TRANSPARENT CELLULOID, NEGATIVE AND  
POSITIVE.

Packed on LIGHT-PROOF Bobbins (patent allowed). Each roll of Negative film has a leader and tail piece of perforated opaque paper, of sufficient length to protect the film before and after exposure, which allows the camera to be charged in daylight, and after exposure a fresh roll can be placed in position IN A MINUTE, avoiding the necessity of using a roll of 500 feet for several exposures.

The **Negative Film** is coated with our Eclipse Emulsion of great sensitiveness, yielding clear and vigorous negatives full of detail.

The **Positive Film** is coated with our celebrated **GELATINO-ALBUMEN EMULSION**, so well and favorably known through our Lantern Transparency Plates, and will be found to yield the most perfect Positives for the MOVING PICTURE MACHINES.

#### PRICE LIST OF EUREKA RIBBON FILMS.

ON EXTRA HEAVY STOCK.

|  |          |                       |
|--|----------|-----------------------|
| Standard width $1\frac{3}{8}$ inches, plain (35 mm.) . . . . .       | Per Foot | $5\frac{1}{2}$ cents. |
| “ “ Perforated to Edison Gauge . . . . .                             | “        | 6 “                   |
| “ “ 35 mm. Perforated Cinematograph Gauge . . . . .                  | “        | 6 “                   |
| Demeny's (French) width 60 mm. $2\frac{3}{8}$ inches plain . . . . . | “        | 9 “                   |
| Biograph, width $2\frac{3}{4}$ inches, plain . . . . .               | “        | 10 “                  |

In lengths of 75 to 300 feet without joint.

The above prices are Net Cash with order, F. O. B. Philadelphia.

Special quotation for 5000 feet and over.

TAKE NOTICE.—The above supersedes all previous quotations.

Manufactured by **JOHN CARBUTT,**

Keystone Dry Plate and  
Film Works.

Wayne Junction,

Philadelphia, U. S. A.

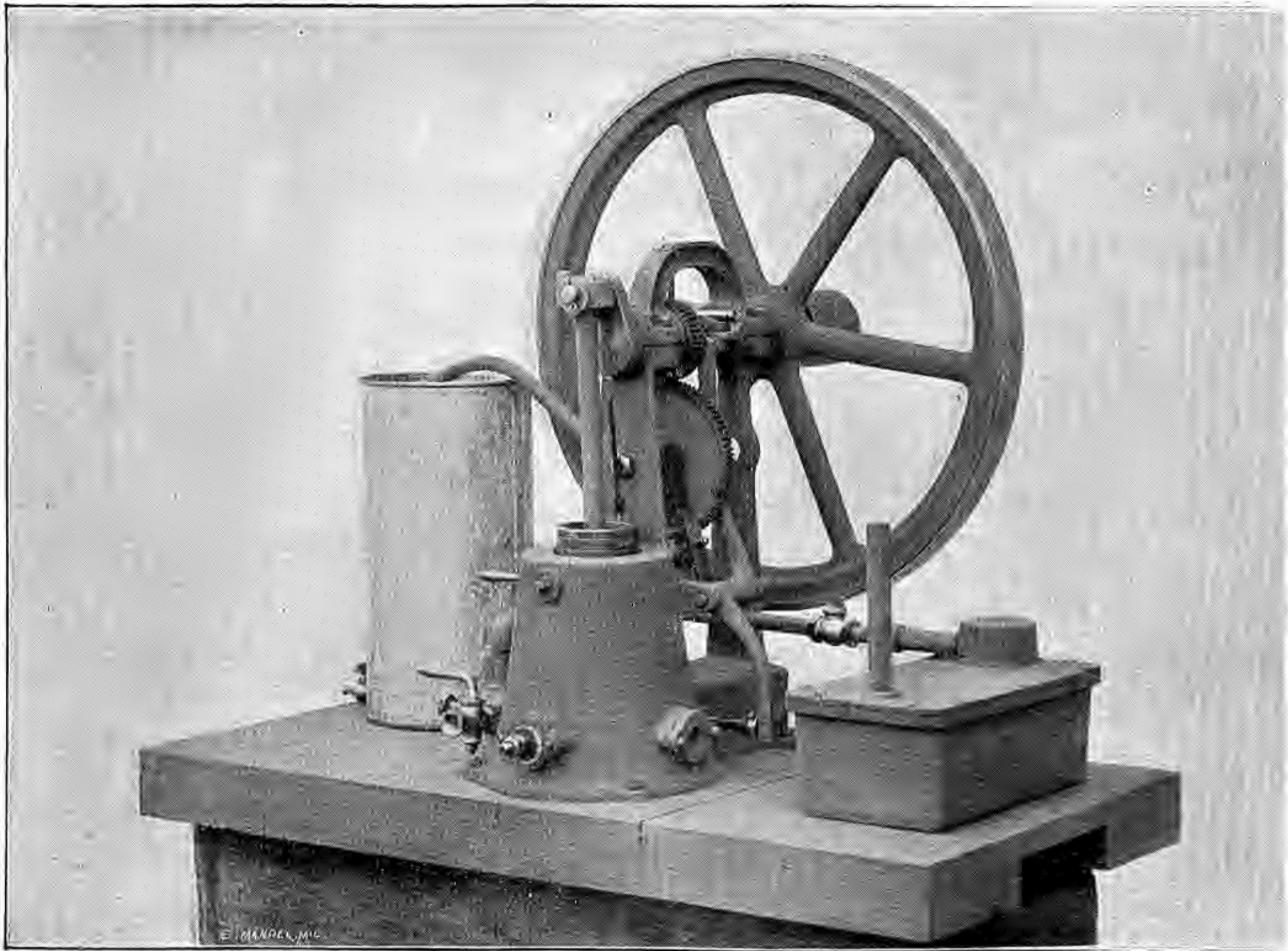

## **E. L. WILLSON & CO.,**

**Pumps and Pumping Machinery, Hydraulic Rams,  
Windmills, Tanks, Towers, Etc.**

AGENTS FOR

**CHARTER GAS AND GASOLINE ENGINES,**

**STEAM ENGINES AND BOILERS.**

514 Twelfth Street N. W.

WASHINGTON, D. C.

---

**PUMP AND WINDMILL REPAIRING A SPECIALTY.**

SPECIMEN OF A NEW PHOTOMECHANICAL  
PROCESS PRINTED FROM STONE \*

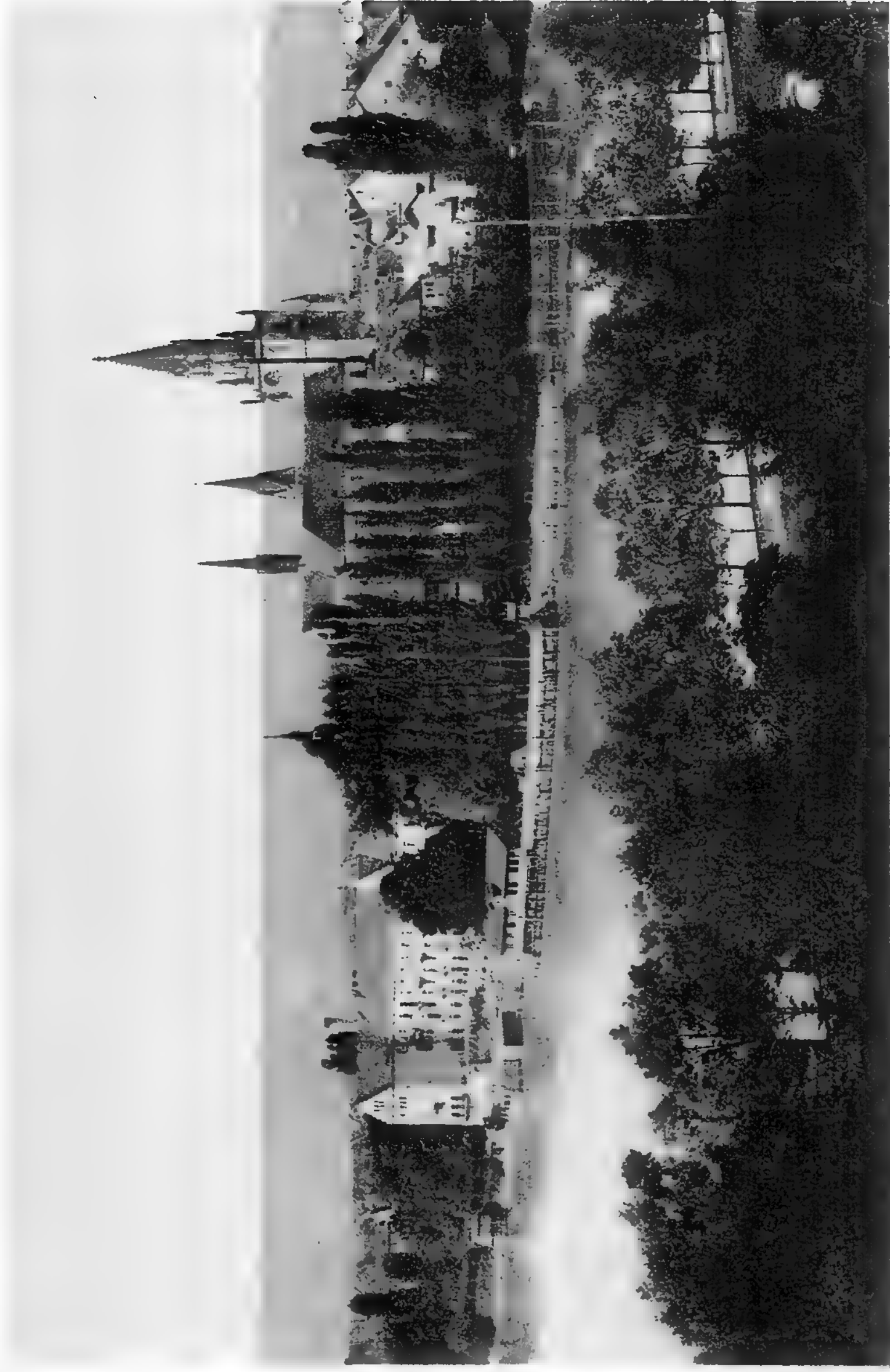

LICENSE OR SOLE REPRESENTATION FOR THE UNITED STATES & CANADA  
MAY BE HAD ON APPLICATION.

FINE ART PRINTING CO. KAUFBEUREN BAVARIA.





**WILSON'S  
PHOTOGRAPHIC MAGAZINE**

is the oldest and best journal published for everyone interested in photography—amateur or professional. It is an independent journal, brightly written, carefully edited, and profusely illustrated. Its information is reliable; it tries to help its readers to better work; it covers the whole field of photography; gives all the news from abroad and home fields; its pictures are engraved from the best work of the year; and a full page actual photograph is given in every issue. 48 pp. Published monthly. Subscription price: \$3 per year, \$1.50 for 6 months. Current number 30 cts. Sample copy 10 cts.

**WILSON'S  
CYCLOPEDIA OF PHOTOGRAPHY**

A comprehensive dictionary of photography covering every department, historical, chemistry, optics, manipulation, formulæ, art. Over 2500 references; 500 closely printed pages. Illustrated. Arranged for instant reference. A complete photographic library in one volume. Price, \$4.00 post-free to any address.

**WILSON'S  
Quarter Century in Photography**

A complete manual of the art science, arranged in chapters, illustrated and giving the experience of 300 workers in all departments. The best all-round text-book published on photography. 528 pp. \$4.00 postpaid.

**PHOTOGRAPHIC MOSAICS**

An illustrated annual record of photographic progress. 1899 volume ready Dec. 1, 1898. 288 pp., 50 full-page illustrations. Paper covers, 50 cts.

Special Prospectus and Sample Magazine,  
10 cents.

**EDWARD L. WILSON,**

Publisher of books relating to Photography,  
853 Broadway, New York.

There are Cameras

. AND .

There are Other Cameras.

We have both, take your choice.  
We also have the . . .

PLATES,  
FILMS,  
PAPERS,  
MOUNTS,  
Etc., etc.

You will want as well.

EVERYTHING IN OPTICS.

H. H. BROWN,

1010 F STREET NORTHWEST,

WASHINGTON, D. C.

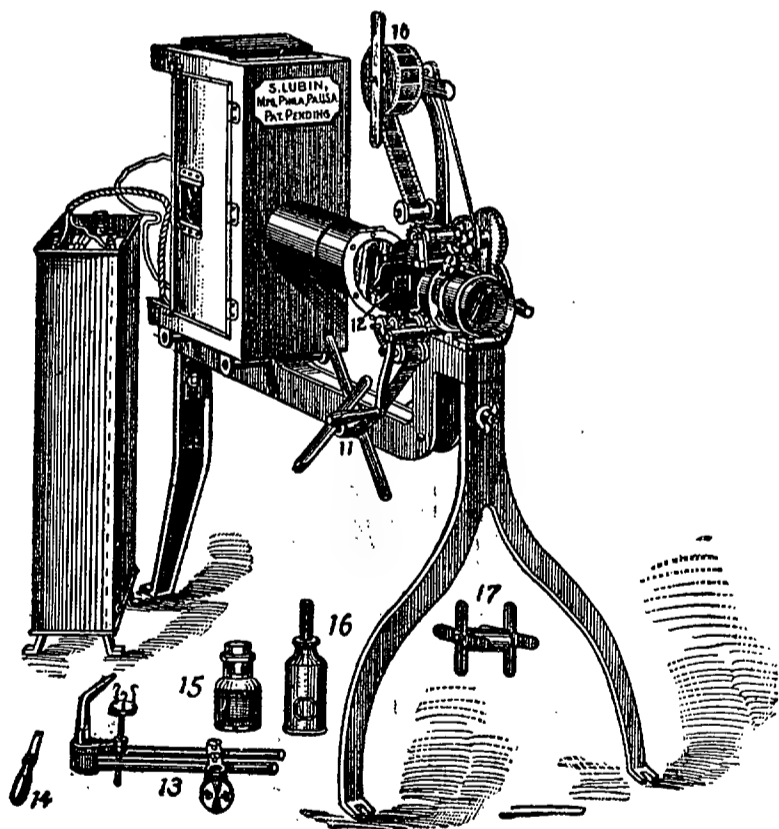

## Lubin's Cineograph

Electric  
Calcium  
Acetylene Gas

Our new **Combined Cineograph and Magic Lantern** projects stationary pictures, announcements, etc., together with the finest moving pictures to be found anywhere. It is all right in quality and price. Investigate its merits for yourself.

Because we have **the largest film plant in the world**, and sell more films and lantern slides than any other manufacturer in existence, we can make very low prices.

Write for catalogue, pamphlets, price-lists, etc., etc., the largest and finest issued anywhere.

S. LUBIN,

21 S. 8th ST.,

PHILADELPHIA, PA.

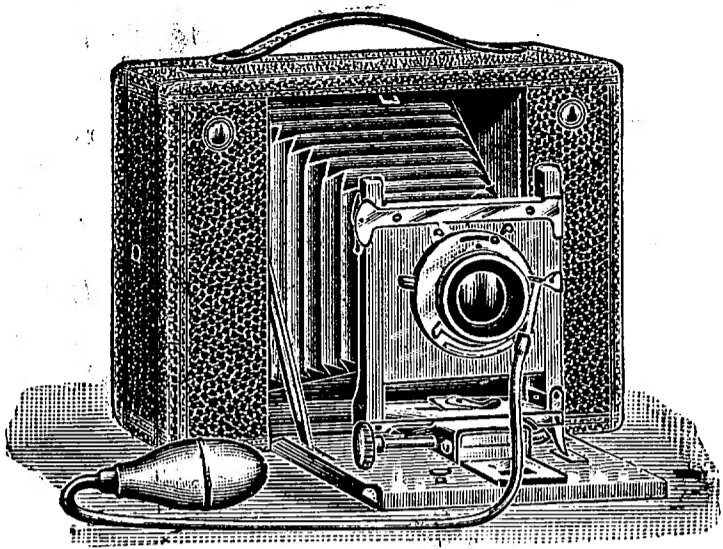

We keep all the Developers given in this book, together with the largest stock of papers, mounts, lenses, cameras, etc., to be found in Washington.

Try stripping the films from the glass and keeping them in indexed books. A hundred pounds of negatives reduced to a one-pound package. You can then take them with you. We keep the stripping medium and the books.

We have no side lines — we devote our entire energies to the photographic business.

If you can't find it

here its

not

in

town.

HOUGHTON & DELANO,

1416 New York Avenue Northwest,

Telephone, 2015-2.

## Electric Light Contractors.

Crocker-Wheeler Electric Motors  
 Burglar Alarms  
 Electric Annunciators  
 Watchman's Time Detector  
 Electric Bells  
 Gas Lighting Apparatus  
 Insulated Wire

AGENTS:

WESTERN  
 ELECTRIC  
 COMPANY,  
 CHICAGO,  
 NEW YORK.

ROYGE & MAREAN,

1423 New York Avenue Northwest,

WASHINGTON, D. C.

# The Law of Patents

---

## HENSEY & ROBINSON, Patent Lawyers,

Practitioners before the Patent Office and all the Courts.

---

### SPECIALTIES:

ELECTRICITY,  
CHEMISTRY,  
PHOTOGRAPHY,  
FOOD PRODUCTS,  
MEDICAL APPLIANCES.

### WATCH FOR THEM.

WE HAVE IN HAND SOME OF  
THE MOST WONDERFUL  
AND MARVELOUS  
INVENTIONS OF THE CENTURY.

---

**Designs, Trademarks, Caveats, Copyrights.**

---

MAIN OFFICE:  
BURCHE BUILDING,  
WASHINGTON, D. C.

WESTERN OFFICE:  
PEOPLES BANK BUILDING,  
DENVER, COLO.

# The Age of Invention

and . . .

# American Inventor.

A HANDSOMELY ILLUSTRATED JOURNAL  
DEVOTED TO THE LATEST  
DEVELOPMENTS IN THE ARTS  
AND SCIENCES.



\$1.00 a Year. Single Copies, 5 Cents.

SEND FOR SAMPLE.

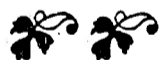

BE INFORMED UPON ALL SUBJECTS. THE WORLD MOVES.  
MOVE WITH IT.

1302 F STREET NORTHWEST,  
WASHINGTON, D. C.

---

Consulting Engineer . . .

---



---

C. FRANCIS JENKINS,

1325 F Street Northwest,

WASHINGTON, D. C.